

Moku:Lab

Specifications



Table of contents

Moku:Lab Hardware	5
Specifications.....	5
Analog I/O.....	5
External trigger input.....	5
Clock reference	5
General characteristics.....	6
General connectivity	6
Hardware measurements.....	8
ADC input noise.....	8
ADC noise-free code resolution.....	8
Compound crosstalk (ADC-ADC & DAC-ADC).....	9
Analog output distortion & noise (single-instrument mode).....	9
Analog output distortion & noise (multi-instrument mode).....	11
Moku:Lab Arbitrary Waveform Generator	12
Description	12
Specifications.....	13
Common.....	13
Waveform.....	13
Moku:Lab Frequency Response Analyzer	15
Description	15
Specifications.....	16
Source.....	16
Input.....	16
Measurement.....	16
Saving data.....	17
Moku:Lab Data Logger	18
Description	18
Specifications.....	19
Input.....	19
Saving data.....	19
Moku:Lab Digital Filter Box	20
Description	20
Specifications.....	21
Inputs.....	21
Filter characteristics.....	21
Selecting the right IIR filter.....	22
Measurements.....	22
Saving data.....	23
Moku:Lab FIR Filter Builder	24
Description	24

Specifications.....	25
Inputs.....	25
Filter characteristics.....	25
Moku:Lab Laser Lock Box	27
Description.....	27
Specifications.....	28
Signal input.....	28
Internal demodulation local oscillator.....	28
External demodulation reference.....	28
Low-pass filter.....	29
Auxiliary oscillator.....	29
Scan waveform.....	29
PID controllers.....	30
Moku:Lab Lock-In Amplifier	31
Description.....	31
Specifications.....	32
Signal channel.....	32
External reference.....	32
Internal reference.....	32
Demodulator.....	33
Signal output.....	33
Moku:Lab Logic Analyzer (Multi-instrument Mode)	35
Description.....	35
Specifications.....	36
Digital I/O.....	36
Horizontal characteristics.....	36
Trigger.....	36
Measurements.....	36
Protocol decoder.....	37
Saving data.....	38
Moku:Lab Logic Analyzer (Single-instrument Mode)	39
Description.....	39
Specifications.....	40
Analog inputs.....	40
Horizontal characteristics.....	40
Trigger.....	40
Measurements.....	40
Protocol decoder.....	40
Saving data.....	41
Moku:Lab Oscilloscope	43
Description.....	43
Specifications.....	44
Vertical characteristics.....	44
Horizontal characteristics.....	44

Trigger.....	44
Measurements.....	45
Integrated waveform synthesizer.....	45
Moku:Lab Phasemeter	47
Description.....	47
Specifications.....	48
Inputs.....	48
Measurement.....	48
Saving data.....	48
Synthesizer.....	49
Moku:Lab PID Controller	50
Description.....	50
Specifications.....	51
Inputs.....	51
Controller.....	51
Measurements.....	52
Moku:Lab Spectrum Analyzer	53
Description.....	53
Specifications.....	54
Frequency.....	54
Amplitude.....	54
Synthesizer.....	54
Moku:Lab Waveform Generator	56
Description.....	56
Specifications.....	57
Common characteristics.....	57
Waveform characteristics.....	57
Modulation.....	58
Moku:Lab Multi-Instrument Mode	61
Description.....	61
Specifications.....	62
Common characteristics.....	62

Moku:Lab Hardware

Specifications

Analog I/O

Analog inputs

Channels	2
Bandwidth (-3 dB)	200 MHz into 50 Ω
Sampling rate	500 MSa/s per channel
Resolution	12-bit
Maximum voltage range	10 V _{pp} into 50 Ω with 20 dB attenuation
Input impedance	50 Ω / 1 M Ω
Input coupling	AC / DC
AC coupling corner (-3 dB)	100 Hz into 50 Ω 30 Hz into 1 M Ω
SNR	60 dBFS (per sample)
Input referred noise	30 nV/ $\sqrt{\text{Hz}}$ above 100 kHz
Connector	BNC

Analog outputs

Channels	2
Bandwidth (-3 dB)	>300 MHz
Sampling rate	1 GSa/s per channel
Resolution	16-bit
Voltage range	2 V _{pp} into 50 Ω
Output impedance	50 Ω
Output coupling	DC
Connector	BNC

External trigger input

External trigger

Trigger waveform	TTL compatible
Trigger bandwidth	DC to 5 MHz
Trigger impedance	Hi-Z
Min trigger level	1.8 V
Max trigger level	5 V
Connector	BNC

Clock reference

On-board clock

On-board clock

Frequency	10 MHz
Stability	< 500 ppb

10 MHz reference input

Expected waveforms	Sine / square
Frequency	10 MHz \pm 250 kHz
Input range	-10 dBm to +10 dBm
Connector	BNC

10 MHz reference output

Waveform type	Square
Output frequency	10 MHz
Output level	-3 dBm
Connector	BNC

General characteristics

General and environmental characteristics

Power consumption	20 W typical 30 W when charging USB
Power voltage range	100 to 240 V, 50/60 Hz
Temperature	Operating: 0 to +45 °C Non-operating: -10 to +60 °C

Electromagnetic compliance



Physical characteristics

Dimensions	Diameter: 22 cm (8.66 in.) Height: 4.3 cm (1.70 in.)
Weight	1.69 kg (3.73 lbs)
Security	Kensington lock compatible

General connectivity

Connectivity

Analog inputs	2 x BNC
---------------	---------

Connectivity

Analog outputs	2 x BNC
Network	Ethernet (10/100 Base-T) Wi-Fi 802.11 b/g/n
USB data port	Micro-USB // For connecting the iPad to the Moku:Lab via USB Requires an Apple USB connection kit and Micro-USB to USB cable
USB charge port	Type-A // For iPad charging only (no data connectivity) Maximum power draw 10 W
SD card	16 GB class 10 supplied
External trigger input	BNC
10 MHz clock reference input	BNC
10 MHz clock reference output	BNC
DC Power	12 V (power module supplied)

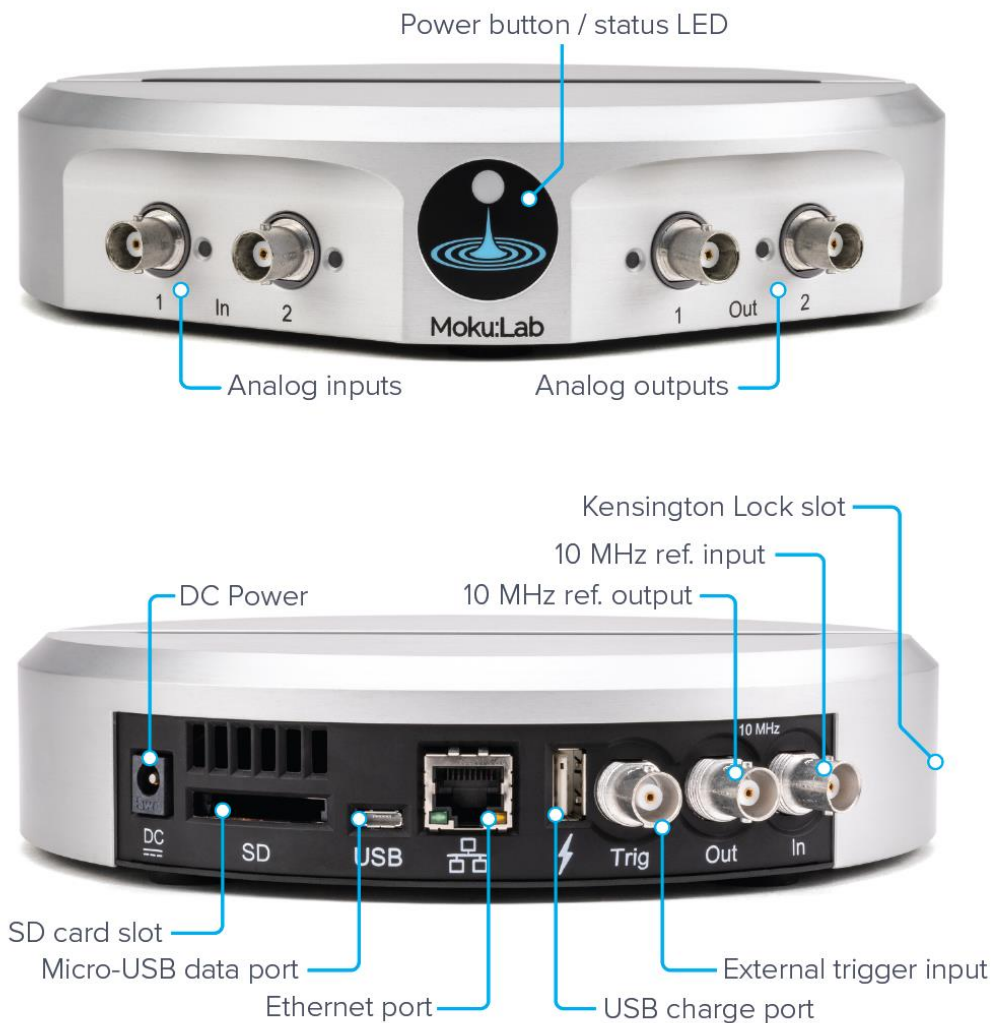

Hardware measurements

ADC input noise

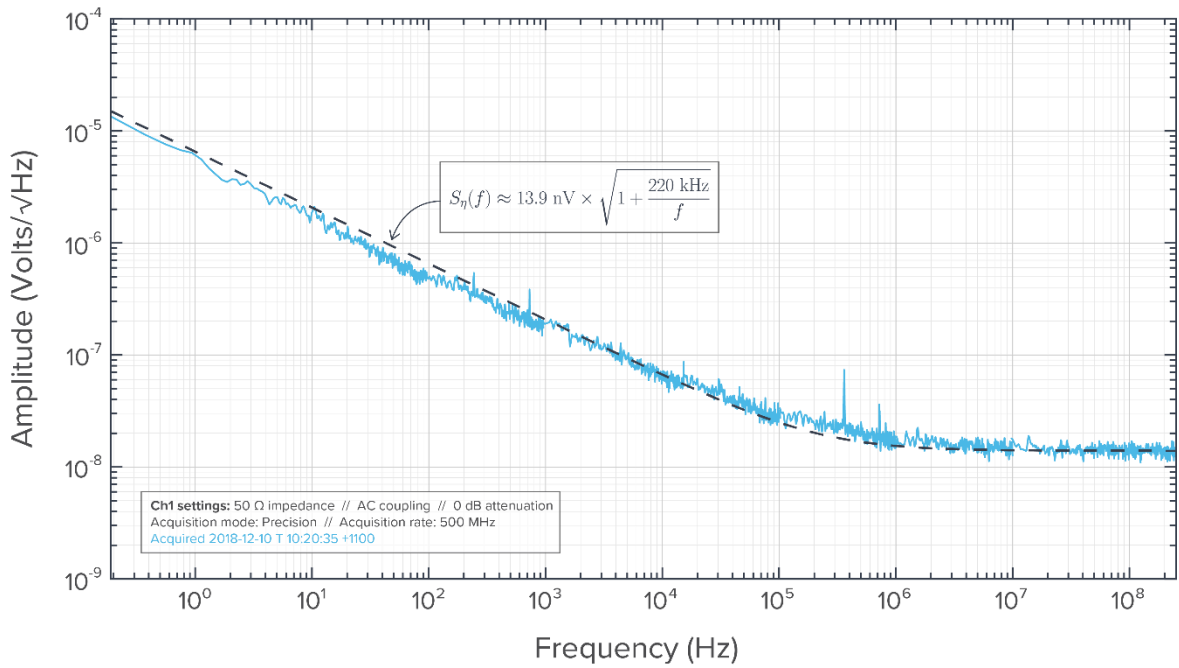

ADC noise-free code resolution

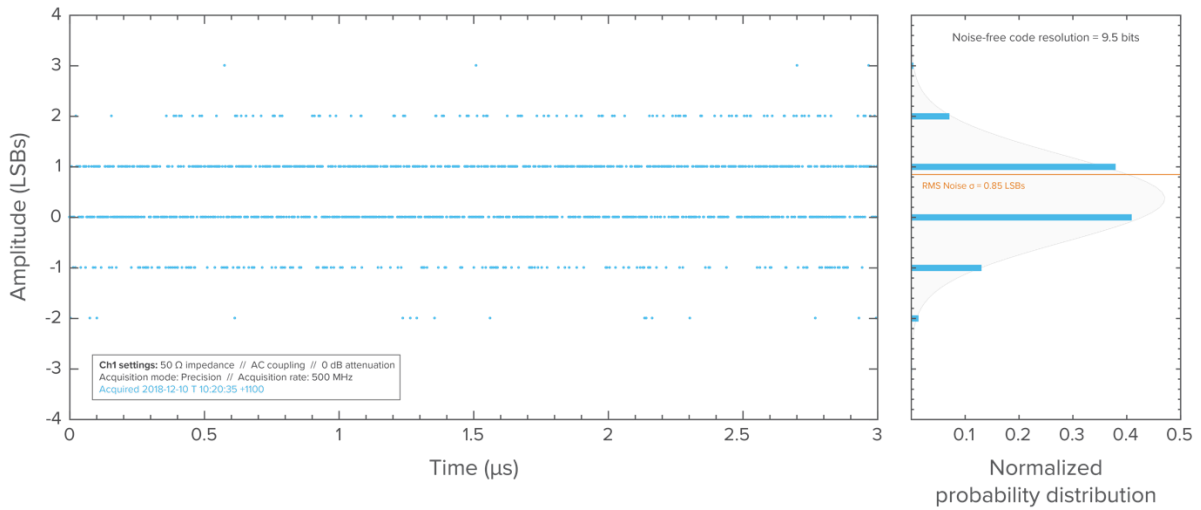

Compound crosstalk (ADC-ADC & DAC-ADC)

50 Ω // AC coupled // 0 dB attenuation

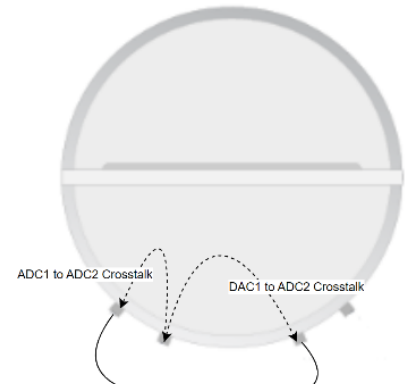
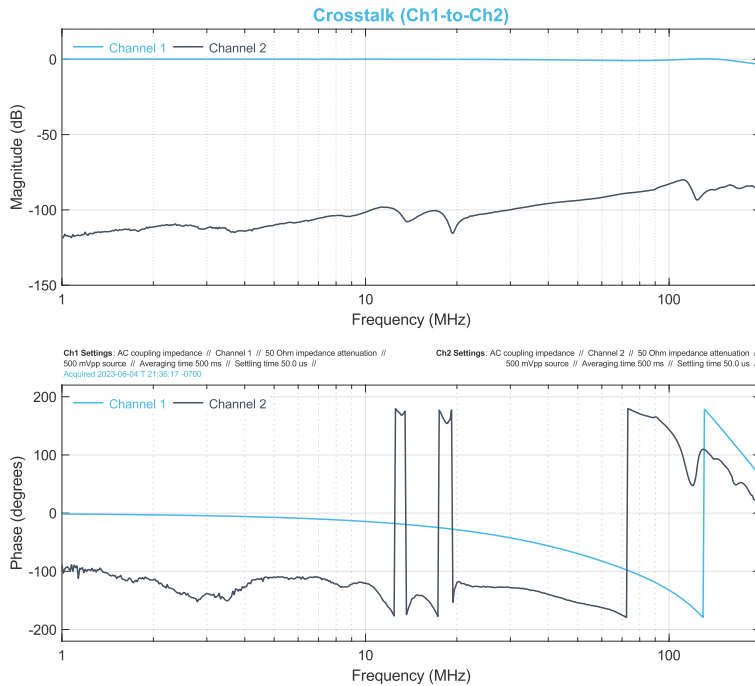

DAC 1 to ADC 2 Crosstalk & ADC 1 to ADC 2 Crosstalk

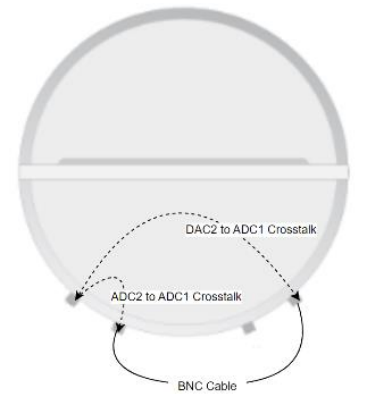
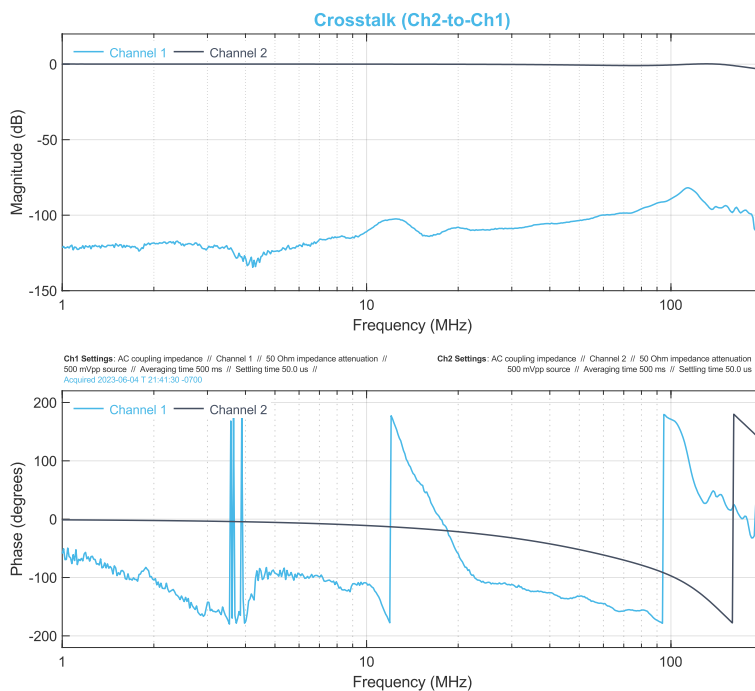

DAC 2 to ADC 1 Crosstalk & ADC 2 to ADC 1 Crosstalk

Analog output distortion & noise (single-instrument mode)

One-tone spectral measurement (50 MHz, -6 dBm, 10 Hz RBW, 10 kHz span)

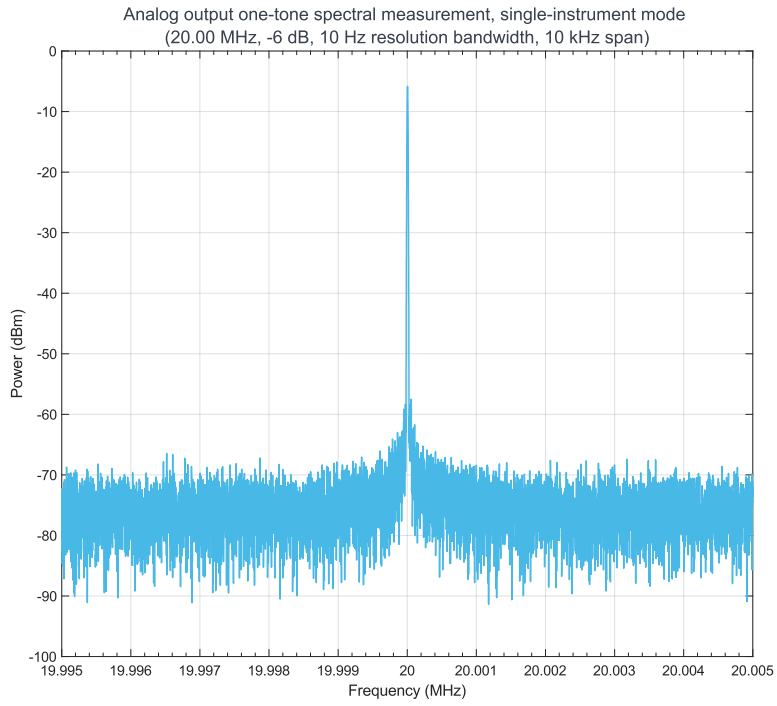

One-tone spectral measurement (50 MHz, -6 dBm, 1 kHz RBW, 500 MHz span)

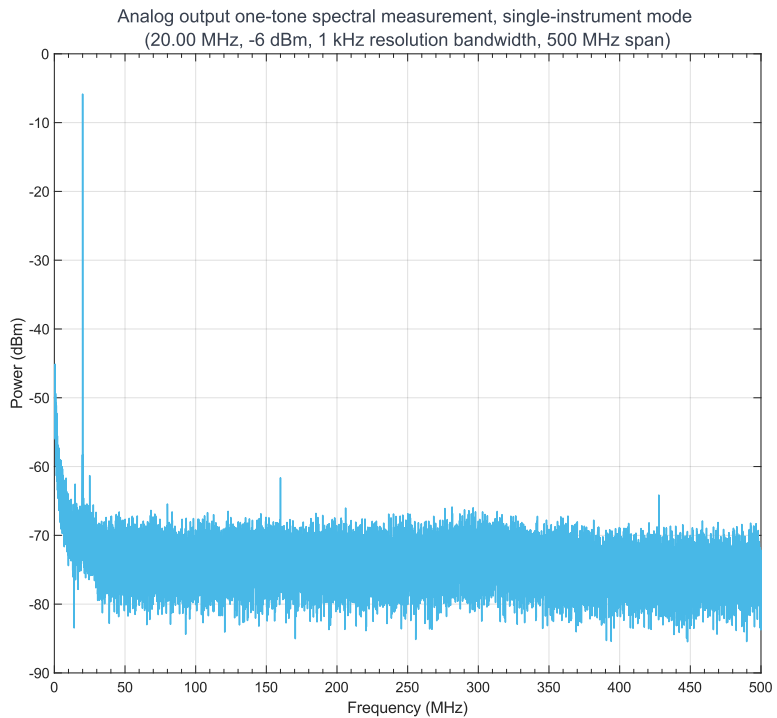

Analog output distortion & noise (multi-instrument mode)

One-tone spectral measurement (50 MHz, -6 dBm, 10 Hz RBW, 10 kHz span)

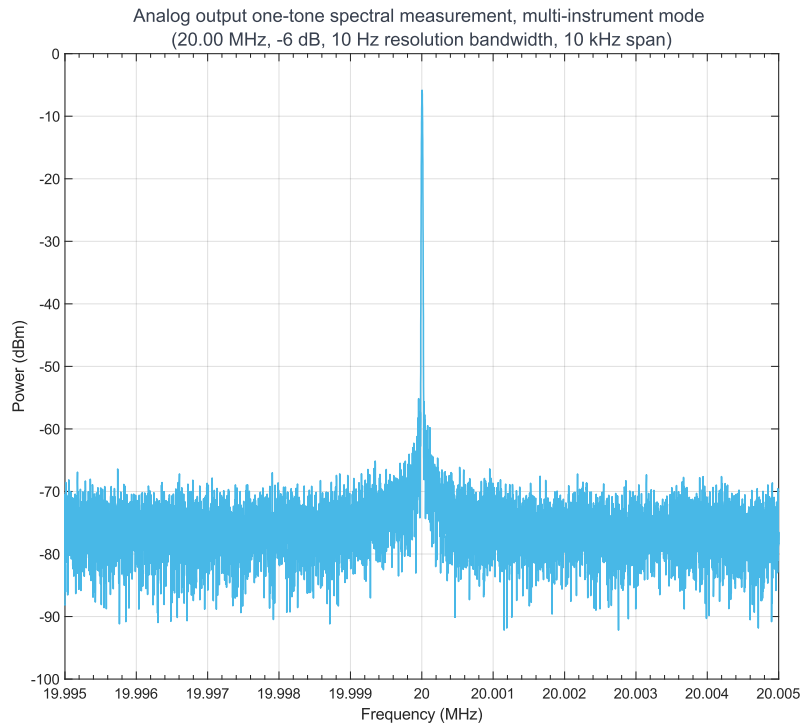

One-tone spectral measurement (50 MHz, -6 dBm, 1 kHz RBW, 500 MHz span)

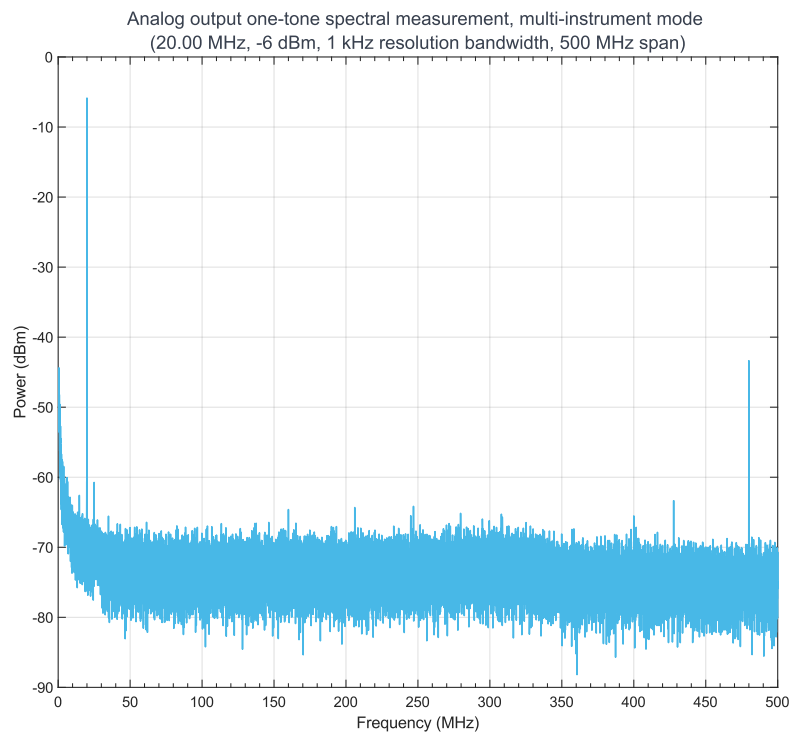



Moku:Lab Arbitrary Waveform Generator

Description

The Moku:Lab Arbitrary Waveform Generator can generate custom waveforms with up to 65,536 points and sample rates of up to 1 GSa/s. Waveforms can be loaded from a file, or input as a piece-wise mathematical function with up to 32 segments, enabling you to generate truly arbitrary waveforms. In pulsed mode, waveforms can be output with more than 262,144 cycles of dead time between pulses, allowing you to excite your system with an arbitrary waveform at regular intervals over extended periods of time.



Features

- Select a pre-set waveform, load custom waveforms from a file, or describe your waveform mathematically using the in-built equation editor
- Configure pulsed arbitrary waveforms with up to 262,144 cycles of dead time between pulses
- Synchronize the phase of both output channels
- Generate arbitrary waveforms with up to 65,536 points



Specifications

Common

Overview

Channels	2
Bandwidth (-3 dB)	> 300 MHz into 50 Ω
Sampling rate	1 GSa/s per channel
Source impedance	50 Ω
Output load	50 Ω / 1 M Ω
Waveforms	Sine, Gaussian, Exponential Fall, Exponential Rise, Sinc, Equation, Cardiac, Custom (from file)

Amplitude

Output voltage range	± 1 V into 50 Ω ± 2 V into 1 M Ω
Resolution	100 μ V

DC offset

Range (peak AC + DC)	± 1 V into 50 Ω ± 2 V into high-impedance
Resolution	100 μ V

Phase offset

Range	0° to 360°
Resolution	0.000 001°

Waveform

Custom

Maximum output rate	125 MSa/s	65536 points
	250 MSa/s	32768 points
	500 MSa/s	16384 points
	1 GSa/s	8192 points
Text file type	Comma- or newline-delimited text	
File import options	SD card, Clipboard, My Files	
Interpolation	None, Linear	
Minimum edge time	2 ns	
Overshoot	$\leq 10\%$ for edge times between 2 ns and 8 ns $\leq 2\%$ for edge times greater than 8 ns	
Jitter (cycle-to-cycle)	< 1 ns	
Pulse width	2 ns to period	



Custom

Period range 1000 s to 8 ns



Moku:Lab Frequency Response Analyzer

Description

The Moku:Lab Frequency Response Analyzer enables you to measure the frequency response of a system in both magnitude and phase using a swept sine output from 10 mHz to 200 MHz. Select from between 32 and 8192 points per sweep and configure settling and averaging time to balance total sweep duration and signal-to-noise ratio.

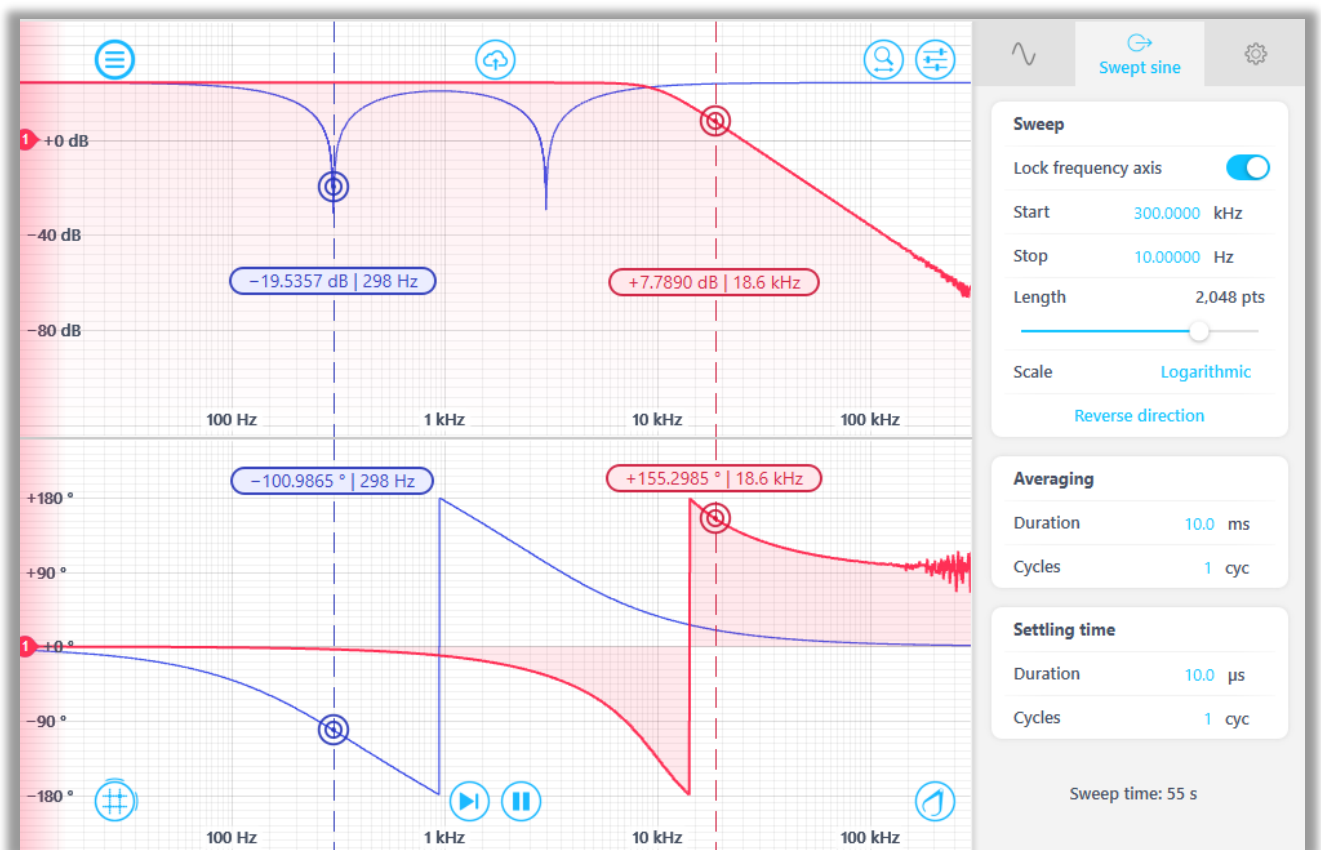

Features

- Measure the frequency response of a system from 10 mHz up to 200 MHz
- Select between Linear or logarithmic sweep scales
- Probe two systems simultaneously or one system at two points
- Add, subtract, multiply or divide response functions as they are acquired with a dedicated math channel
- Use cursors and markers to accurately measure features in both magnitude and phase
- Precisely adjust settling and averaging time to suit device under test



- Calibrate your measurement to compare systems or compensate for delays

Specifications

Source

Source

Waveform	Sine
Frequency range	10 mHz to 200 MHz
Frequency resolution	1 μ Hz
Sweep type	Linear / Logarithmic
Sweep points	32, 64, 128, 256, 512, 1024, 2048, 4096, 8192
Output amplitude range	± 0.5 mV to ± 1 V into 50 Ω
Output load	50 Ω / 1 M Ω
Source impedance	50 Ω

Input

Input characteristics

Input impedance	50 Ω / 1 M Ω	
Input coupling	AC / DC	
Input attenuation	0 dB / 20 dB	
Input voltage range	± 0.5 V into 50 Ω with 0 dB attenuation ± 5 V into 50 Ω with 20 dB attenuation	
Input noise	30 nV/ \sqrt Hz above 100 kHz	
Flatness prior to calibration	10 mHz to 100 kHz	< 0.02 dB into 50 Ω < 0.05 dB into 1 M Ω
	100 kHz to 1 MHz	< 0.02 dB into 50 Ω < 0.03 dB into 1 M Ω
	1 MHz to 50 MHz	< 0.3 dB into 50 Ω < 0.7 dB into 1 M Ω
	1 MHz to 150 MHz	< 0.7 dB into 50 Ω < 2.8 dB into 1 M Ω
	150 MHz to 200 MHz	< 3.5 dB into 50 Ω < 6.4 dB into 1 M Ω
Crosstalk	< -80 dB at 0 dB attenuation	
	< -60 dB at 20 dB attenuation	

Measurement

Measurement characteristics

Settling time	Min.	Greater of 1 μ s or 1 cycle
	Max.	10.0 seconds
Averaging time	Min.	Greater of 1 μ s or 1 cycle
	Max.	10.0 seconds



Measurement characteristics

Noise-floor <ul style="list-style-type: none">100 ms averaging time500 mV_{pp} amplitudeDC coupled input	10 mHz to 100 kHz	-100 dB into 0 dB attenuation -80 dB into 20 dB attenuation
	100 kHz to 1 MHz	-125 dB into 0 dB attenuation -105 dB into 20 dB attenuation
	1 MHz to 50 MHz	-130 dB into 0 dB attenuation -110 dB into 20 dB attenuation
	50 MHz to 200 MHz	-120 dB into 0 dB attenuation -100 dB into 20 dB attenuation
Normalization	Calibrate magnitude and phase using a reference sweep ¹	
Calibrated gain error	<0.05 dB	
Calibrated phase error	< 0.5°	

Saving data

Saving data

File formats	Plain text: records data using a standard *.csv format
	MATLAB: records data using MathWorks' *.mat format which can be opened using MATLAB
Export modes	SD Card, Dropbox, E-mail and iCloud, My Files (iOS 11)

¹ The normalization feature can be used to isolate the magnitude and phase response of the system under test by compensating for deviations in magnitude and phase caused by delays (e.g., caused by cables) and the frequency response of the Moku:Lab analog frontend.



Moku:Lab Data Logger

Description

The Moku:Lab Data Logger enables you to log data directly to an SD card for long-term measurements at rates of up to 250 kSa/s, where the duration is limited only by the capacity of the SD card. Data saved to internal memory can be uploaded to the cloud for analysis once the measurement is complete.



Features

- Record two channels of data at up to 125 kSa/s to SD card
- Effortlessly upload recorded data to the cloud or local computer for analysis
- Easily download log files to your computer for analysis. Built-in conversion tool to convert the binary data to .csv, .mat, HDF5, or NumPy format
- Schedule your log to start on a delay of up to 10 days



Specifications

Input

Voltage

Input voltage range	± 0.5 V into 50 Ω with 0 dB attenuation ± 5 V into 50 Ω with 20 dB attenuation
Input impedance	50 Ω / 1 M Ω
Input coupling	AC / DC

Saving data

Saving data

File formats	Binary: records data using a proprietary *.li format for high-speed data logging. Note: data saved using the *.li format can be converted to plain text using the LI file converter available here: https://www.liquidinstruments.com/software/utilities/
Export modes	SD Card, Dropbox, E-mail and iCloud, My Files (iOS 11)
Maximum sampling rate	250 kSa/s into SD card (single channel) 125 kSa/s into SD card (two channels)
Acquisition mode	Normal and Precision ²
Delayed log start time	Up to 240 hours
Log duration	1 second up to 10000 hours

² Precision mode samples the waveform at the full rate and applies a finite impulse response (FIR) low-pass filter to attenuate noise above the usable bandwidth of the measurement sampling rate and prevent aliasing.



Moku:Lab Digital Filter Box

Description

With the Moku:Lab Digital Filter Box, you can interactively design and generate different types of infinite impulse response filters with output sampling rates of between 122 kHz and 15.625 MHz. Select between lowpass, highpass, bandpass and bandstop filter shapes with up to seven fully configurable types including Butterworth, Chebyshev and Elliptical.

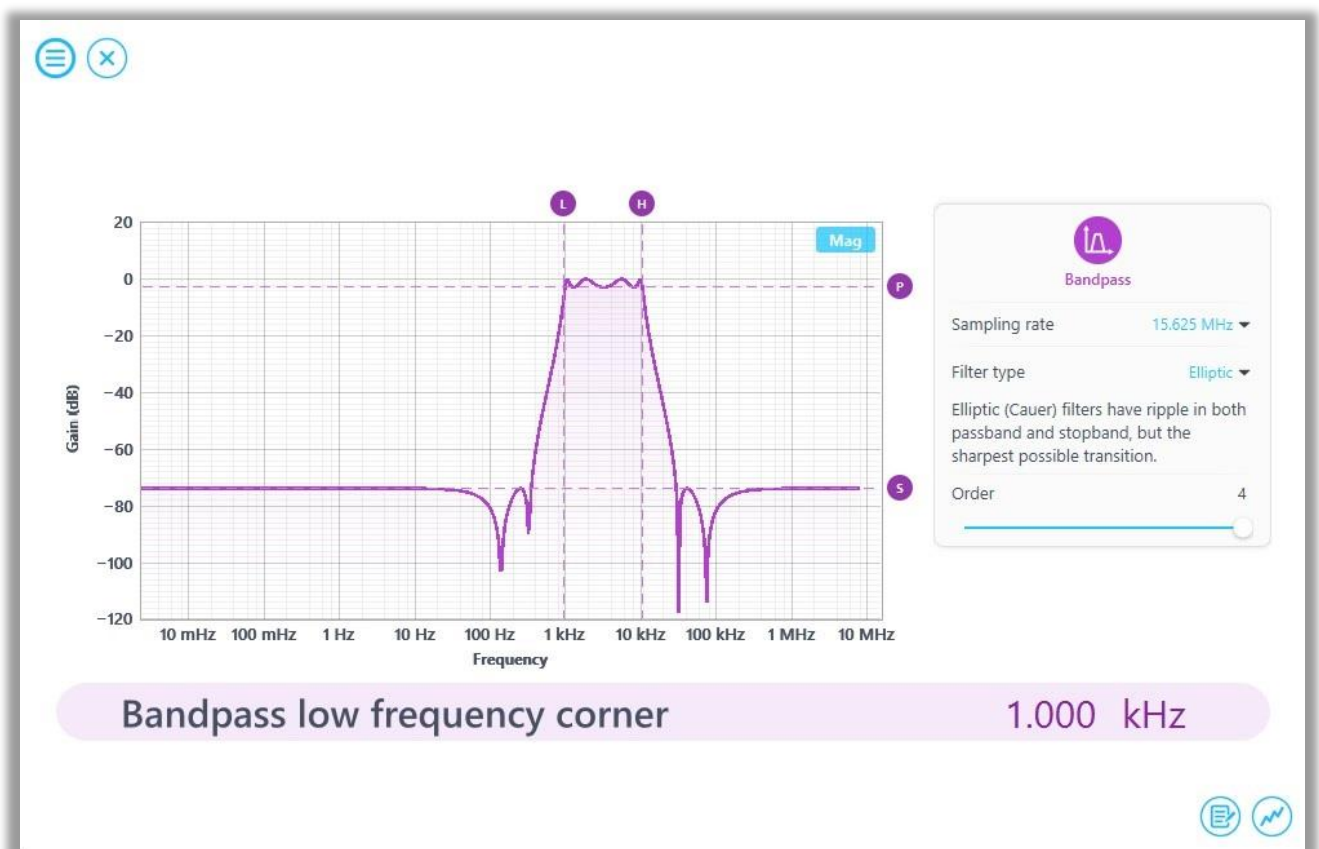

Features

- Design IIR filters using an interactive Bode plot
- Observe and log signals at different stages in the digital signal processing chain using probe points³
- View the frequency response of your filter in both magnitude and phase
- Filter up to two channels of data simultaneously with the ability to blend input signals using a control matrix

³ See [Moku:Lab Data Logger](#) or [Moku:Lab Oscilloscope](#) for specifications on integrated instruments



- Implement custom filters by uploading your own coefficients

Specifications

Inputs

Input characteristics

Channels	2
Input control matrix coefficients	-20 to +20
Input impedance	50 Ω / 1 M Ω
Input coupling	AC / DC
Input attenuation	0 dB / 20 dB
Input voltage range	± 0.5 V into 50 Ω with 0 dB attenuation ± 5 V into 50 Ω with 20 dB attenuation

Filter characteristics

Pre-filter

Input offset range	± 1 V
Input offset resolution	1 mV
Input gain range	-40 dB to +40 dB
Input gain resolution	0.1 dB

Post-filter

Output offset range	± 1 V
Output offset resolution	100 μ V
Output gain range	-40 dB to +40 dB
Output gain resolution	0.1 dB

General filter characteristics

Filter shapes	Lowpass, Highpass, Bandpass, Bandstop, Custom
Sampling rates	122.07 kHz, 1.9531 MHz, 15.625 MHz
Filter types	Butterworth, Chebyshev I, Chebyshev II, Elliptic, Cascaded, Bessel, Gaussian, Legendre
Passband ripple	0.1 dB to 10 dB
Stopband attenuation	10 dB to 100 dB
Zoom view	Allows the user to zoom in on the filter's frequency response

Low-pass filter

Filter order	2, 4, 6, 8
Low-pass corner frequency	23.45 mHz to 54.93 kHz at 122.07 kHz sampling rate 3.002 Hz to 7.031 MHz at 15.625 MHz sampling rate



High-pass filter

Filter order	2, 4, 6, 8
High-pass corner frequency	289.5 mHz to 54.93 kHz at 122.07 kHz sampling rate 37.05 Hz to 7.031 MHz at 15.625 MHz sampling rate

Band-pass / band-stop filter

Filter order	2, 4
Low corner frequency	1.221 Hz to 54.93 kHz at 122.07 kHz sampling rate 156.3 Hz to 7.031 MHz at 15.625 MHz sampling rate
High corner frequency	2.002 Hz to 54.93 kHz at 122.07 kHz sampling rate 206.3 Hz to 7.031 MHz at 15.625 MHz sampling rate
Minimum bandwidth	390 mHz at 122.07 kHz sampling rate 50 Hz at 15.625 MHz sampling rate

Selecting the right IIR filter

Filter type

Butterworth	Butterworth filters have a maximally flat passband and a monotonic frequency response, making them a good all-round filter type suitable for most applications.
Chebyshev I	Chebyshev I filters have ripple in the passband but a sharper transition than Butterworth filters, making them useful for applications requiring aggressive stopband attenuation but can tolerate passband ripple between 0.1 dB and 10 dB.
Chebyshev II	Chebyshev II filters have ripple in the stopband but a sharper transition than Butterworth filters, making them useful in applications requiring flat passbands and aggressive stopband attenuation.
Elliptical	Elliptical (Cauer) filters have ripple in both passband and stopband, but also have the sharpest possible transition. Elliptical filters are useful in applications requiring extremely aggressive stopband attenuation.
Cascaded	Cascaded first-order filters have zero overshoot in the time domain.
Bessel	Bessel filters have maximally flat group and phase delay in the passband, thus preserving the wave shape of passband signals.
Gaussian	Gaussian filters have the minimum possible group delay, and a step response with no overshoot and minimum rise and fall time.
Legendre	Legendre (Optimum L) filters have the sharpest possible transition while maintaining a monotonic frequency response.

Measurements

Integrated oscilloscope

Acquisition mode	Normal, Precision, and Deep memory
------------------	------------------------------------



Integrated oscilloscope

Maximum sampling rate	500 MSa/s
Memory depth	4.2 M samples per channel 37.94 ms at 2 ms/div
Averaging (linear)	Off, 2 to 100 waveforms
Persistence	Off, 100 ms to 10 s, infinite
Interpolation	Linear, SinX/X, Gaussian

Measurements

Time measurements	Frequency, period, phase, duty cycle, positive pulse width, negative pulse width, rise time, fall time, rise rate, fall rate
Amplitude measurements	Peak-to-peak, amplitude, maximum, minimum, mean, cycle mean, RMS, cycle RMS, standard deviation, high-level, low-level, overshoot, undershoot, fringe vis.
Math	Add, subtract, multiply, divide, XY mode, integrate, differentiate, FFT, min hold, max hold, arbitrary equation mode (using equation editor)
Visualisations	Histogram, time trend

Saving data

Saving data

File formats	Binary: records data using a proprietary *.li format for high-speed data logging. Note: data saved using the *.li format can be converted to plain text using the LI file converter available here: https://www.liquidinstruments.com/software/utilities/
Export modes	SD Card, Dropbox, E-mail and iCloud, My Files (iOS 11)
Maximum sampling rate	250 kSa/s into SD card (single channel) 125 kSa/s into SD card (two channels)
Acquisition mode	Normal and Precision
Delayed log start time	Up to 240 hours
Log duration	1 second up to 10000 hours



Moku:Lab FIR Filter Builder

Description

With the Moku:Lab FIR Filter Builder, you can design and implement lowpass, highpass, bandpass, and bandstop finite impulse response (FIR) filters with up to 14,819 coefficients at a sampling rate of 244.1 kHz and a sampling rate up to 15.63 MHz with a coefficient number of 232. The Moku iPad interface allows you to fine tune your filter's response in the frequency and time domains to suit your specific application. Select between four frequency response shapes, five common impulse responses, and up to eight window functions.

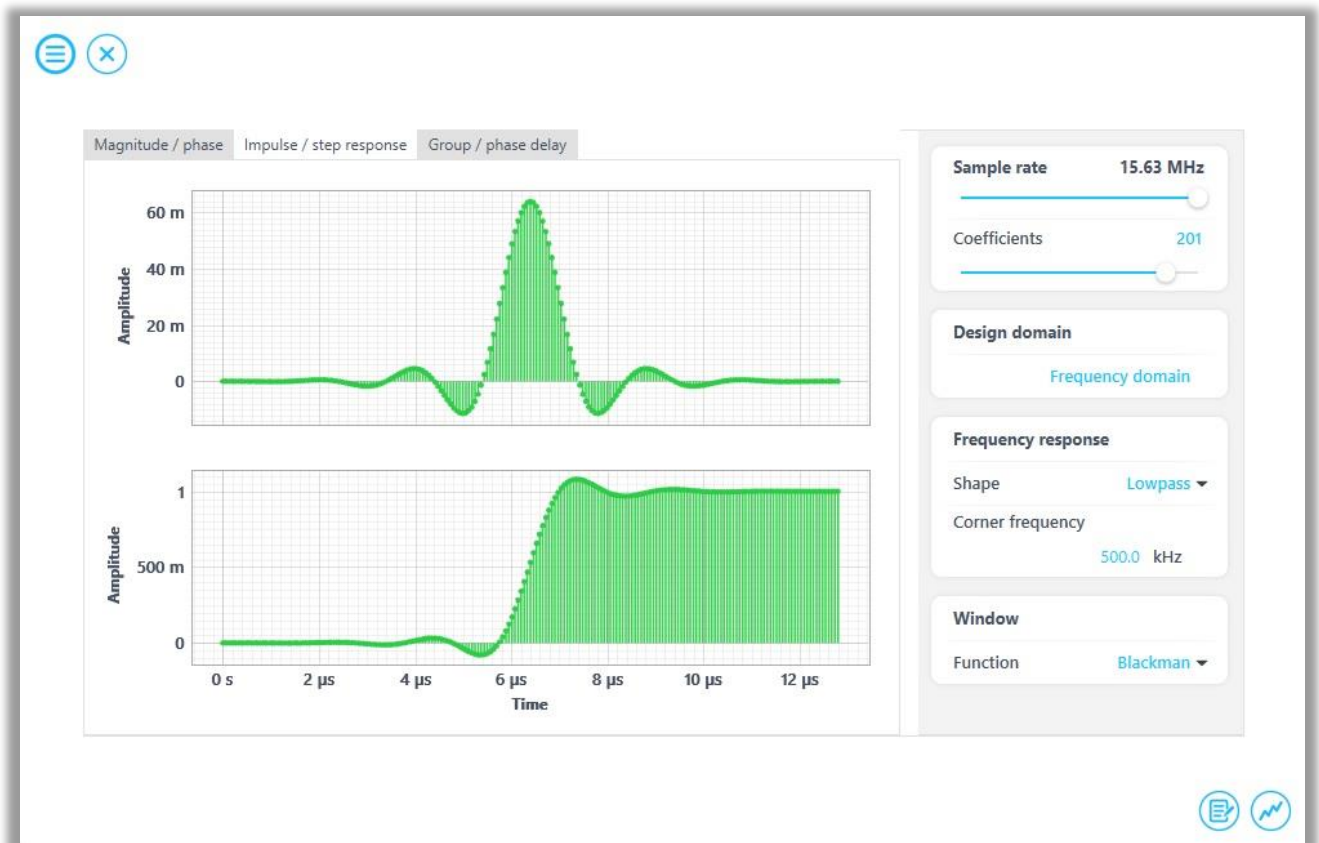

Features

- Design filters in the time domain or in the frequency domain using common impulse responses and window functions
- Upload your own filter coefficients, or define your own custom impulse response mathematically using an equation editor
- View your filter's transfer function, impulse and step response, or group and phase delay



- Observe and log signals at different stages in the digital signal processing chain using probe points⁴

Specifications

Inputs

Input characteristics

Channels	2
Input control matrix coefficients	-20 to +20
Input impedance	50 Ω / 1 M Ω
Input coupling	AC / DC
Input attenuation	0 dB / 20 dB
Input voltage range	± 0.5 V into 50 Ω with 0 dB attenuation ± 5 V into 50 Ω with 20 dB attenuation

Filter characteristics

Pre-filter

Input offset range	± 1 V
Input offset resolution	1 mV
Input gain range	-40 dB to +40 dB
Input gain resolution	0.1 dB

Post-filter

Output offset range	± 1 V
Output offset resolution	100 μ V
Output gain range	-40 dB to +40 dB
Output gain resolution	0.1 dB

General filter characteristics

Sampling rates	122.1 kHz, 244.1 kHz, 488.3 kHz, 976.6 kHz, 1.953 MHz, 3.906 MHz, 7.813 MHz, 15.63 MHz
Number of coefficients	2 to 232 @ 15.63 MHz 2 to 464 @ 7.813 MHz 2 to 928 @ 3.906 MHz 2 to 1856 @ 1.953 MHz 2 to 3712 @ 976.6 kHz 2 to 7424 @ 488.3 kHz 2 to 14819 @ 244.1 kHz and 122.1 kHz

⁴ See [Moku:Lab Data Logger](#) or [Moku:Lab Oscilloscope](#) for specifications on integrated instruments



General filter characteristics

Design domains	Time (impulse response) Frequency (frequency response)
----------------	---

Filter design / configuration

Display options	Magnitude / Phase Impulse / Step Response Group / Phase Delay
Frequency response	Lowpass, highpass, bandpass, bandstop
Impulse response	Rectangular, Sinc, Triangular, Gaussian, Equation, Custom
Window	None, Bartlett, Hann, Hamming, Blackman, Nuttall, Tukey, Kaiser
Minimum filter cut-off frequency	Sampling rate / 10,000 <ul style="list-style-type: none">e.g., $f_{\min} = 12.21 \text{ Hz @ } 122.1 \text{ kHz}$
Maximum filter cut-off frequency	Sampling rate / 2 (approximately) <ul style="list-style-type: none">e.g., $f_{\max} = 59.81 \text{ kHz @ } 122.1 \text{ kHz}$



Moku:Lab Laser Lock Box

Description

The Moku:Lab Laser Lock Box enables you to stabilize a laser's frequency to a reference cavity or atomic transition using high-performance modulation locking techniques. The Laser Lock Box includes a 'Tap-to-Lock' feature, enabling you to quickly lock to any zero-crossing on the demodulated error signal.

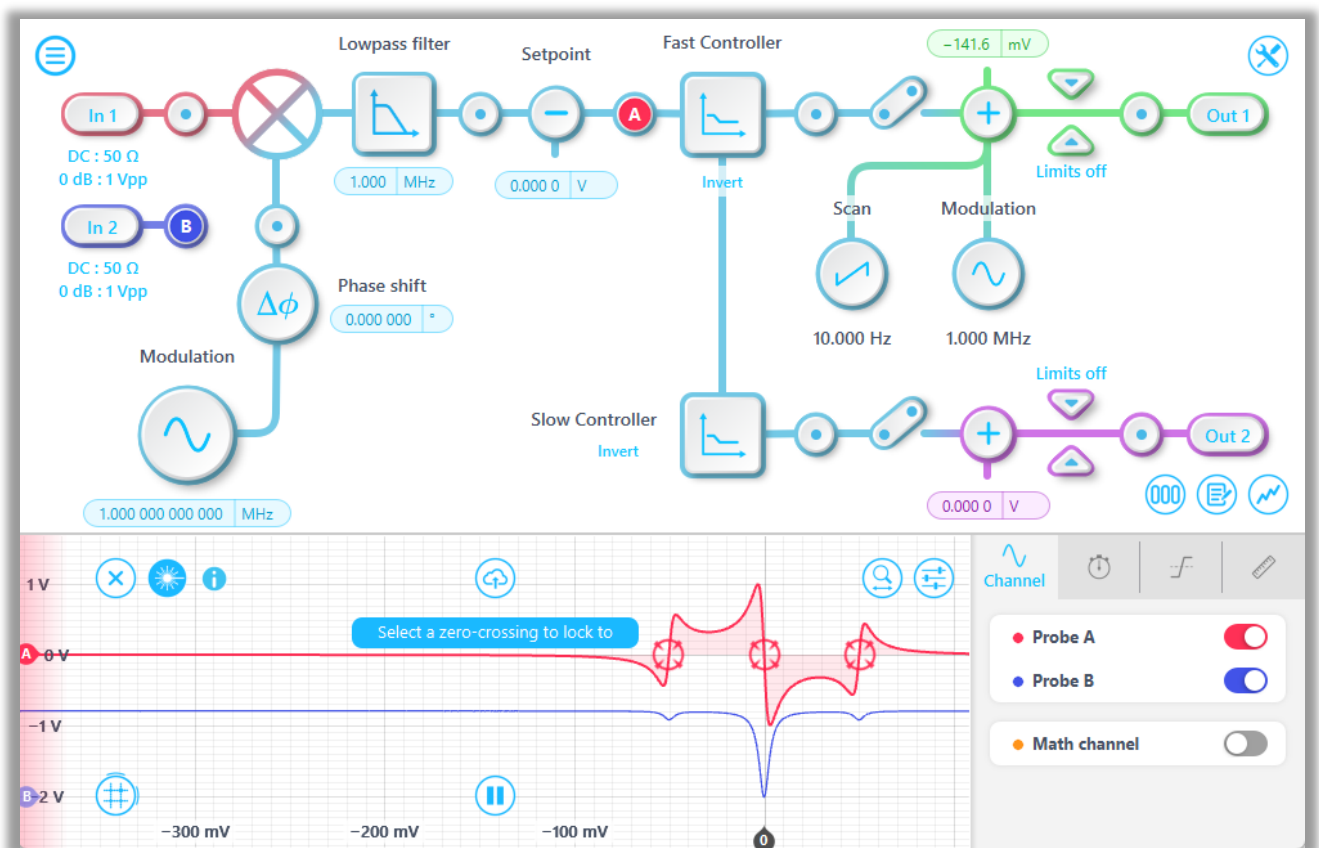

Features

- Generate modulation signals at up to 200 MHz
- Demodulate signals with internal or external local oscillators
- Scan resonances with sawtooth or triangle waveforms at up to 10 MHz
- Observe and log signals at different stages in the digital signal processing chain using probe points⁵
- Quickly lock to any zero-crossing in the error signal using the 'Tap-to-Lock' feature
- Filter demodulated signals with up to fourth order infinite-impulse response filters

⁵ See [Moku:Lab Data Logger](#) or [Moku:Lab Oscilloscope](#) for specifications on integrated instruments



- Individually configure high- and low-bandwidth PID controllers for fast and slow feedback

Specifications

Signal input

Signal input

Input coupling	AC / DC
Input impedance	50 Ω / 1 M Ω
AC coupling corner (-3 dB)	100 Hz into 50 Ω 30 Hz into 1 M Ω
Frequency range	DC to 200 MHz
Input gain	-20 dB / 0 dB
Gain accuracy	\pm 1%
Input range	10 V _{pp} with -20 dB input gain 1 V _{pp} with 0 dB input gain
Input noise	< 10 nV/ \sqrt Hz above 1 MHz at 1 V _{pp} input range

Internal demodulation local oscillator

Internal reference waveform

Waveform	Sine
Frequency range	1 mHz to 200 MHz
Frequency resolution	1 μ Hz
Phase offset range	0 to 360°
Phase offset resolution	0.000 001°
Output impedance	50 Ω
Can be phase-locked to external 10 MHz timebase?	Yes

External demodulation reference

Demodulation reference input

Input coupling	AC / DC
Input impedance	50 Ω / 1 M Ω
Frequency range	DC to 200 MHz
Input gain	-20 dB / 0 dB
External reference modes	Direct, phase-locked

Phase-locked loop

PLL frequency range	10 Hz to 200 MHz
PLL tracking bandwidth	100kHz, 10 kHz, 1 kHz, 100 Hz, 10 Hz, 1 Hz
Phase offset range	0 to 360°
Phase offset resolution	0.000 001°



Phase-locked loop

Orthogonality	$90^\circ \pm 0.000,002^\circ$
---------------	--------------------------------

Low-pass filter

Low-pass filter

Filter architecture	Infinite Impulse Response (IIR)
Filter shape	Low-pass filter
Sampling rate	31.25 MHz
Filter types	Butterworth, Chebyshev I, Chebyshev II, Elliptic, Cascaded, Bessel, Gaussian, Legendre
Filter order	2, 4
Min. corner frequency	1.040 kHz
Max. corner frequency	14.06 MHz
Passband ripple ⁶	0.1 dB to 10 dB
Stopband attenuation ⁷	10 dB to 100 dB

Auxiliary oscillator

Auxiliary oscillator waveform

Waveform	Sine
Frequency range	DC to 200 MHz
Frequency resolution	1 μ Hz
Amplitude range (AC)	1 mV _{pp} to 2 V _{pp} into 50 Ω
Amplitude resolution	1 mV
Offset range (DC)	± 1 V
Output limit (AC + DC)	± 1 V into 50 Ω
Amplitude accuracy	1%
Output distortion	< -70 dBc for frequencies lower than 10 kHz < -60 dBc for frequencies greater than 10 kHz
Output impedance	50 Ω
Can be phase-locked to demodulation local oscillator?	Yes

Scan waveform

Scanning waveform

Waveform	Positive ramp, Negative ramp, Triangle
Frequency range	DC to 10 MHz

⁶ Applies to Chebyshev I and Elliptical filter types.

⁷ Applies to Chebyshev II and Elliptical filter types.



Scanning waveform

Frequency resolution	<1 μ Hz
Amplitude range (AC)	1 mV _{pp} to 1 V _{pp} into 50 Ω
Amplitude resolution	1 mV
Offset range (DC)	\pm 1 V
Output limit (AC + DC)	\pm 1 V into 50 Ω
Amplitude accuracy	1%
Output impedance	50 Ω

PID controllers

Set point

Set point range	-1 V to +1 V
Set point resolution	100 μ V

Fast controller

Sampling rate	31.25 MHz
Proportional gain	\pm 60 dB
Integrator crossover frequency	1.25 Hz to 125 kHz (single integrator) 1.25 Hz to single integrator crossover frequency (double integrator)
Int. saturation crossover frequency	1.25 Hz to single integrator crossover frequency
Integrator gain range	Proportional gain to +80 dB
Differentiator crossover frequency	12.5 Hz to 1.25 MHz
Diff. saturation crossover frequency	Differentiator crossover frequency to 1.25 MHz
Differentiator gain range	Proportional gain to +80 dB

Slow controller

Sampling rate	488.28 kHz
Proportional gain	\pm 60 dB
Integrator crossover frequency	19.53 mHz to 1.953 kHz
Int. saturation crossover frequency	19.53 mHz to integrator crossover frequency
Integrator gain range	Proportional gain to +80 dB
Differentiator crossover frequency	195.3 mHz to 19.53 kHz
Diff. saturation crossover frequency	Differentiator crossover frequency to 19.53 kHz
Differentiator gain range	Proportional gain to +80 dB



Moku:Lab Lock-In Amplifier

Description

The Moku:Lab digital Lock-In Amplifier supports dual-phase demodulation (XY/R θ) from 1 mHz to 200 MHz with up to 120 dB of dynamic reserve. It also features an integrated 2-channel oscilloscope and data logger, enabling you to observe signals at up to 500 MSa/s and log data at up to 250 kSa/s.

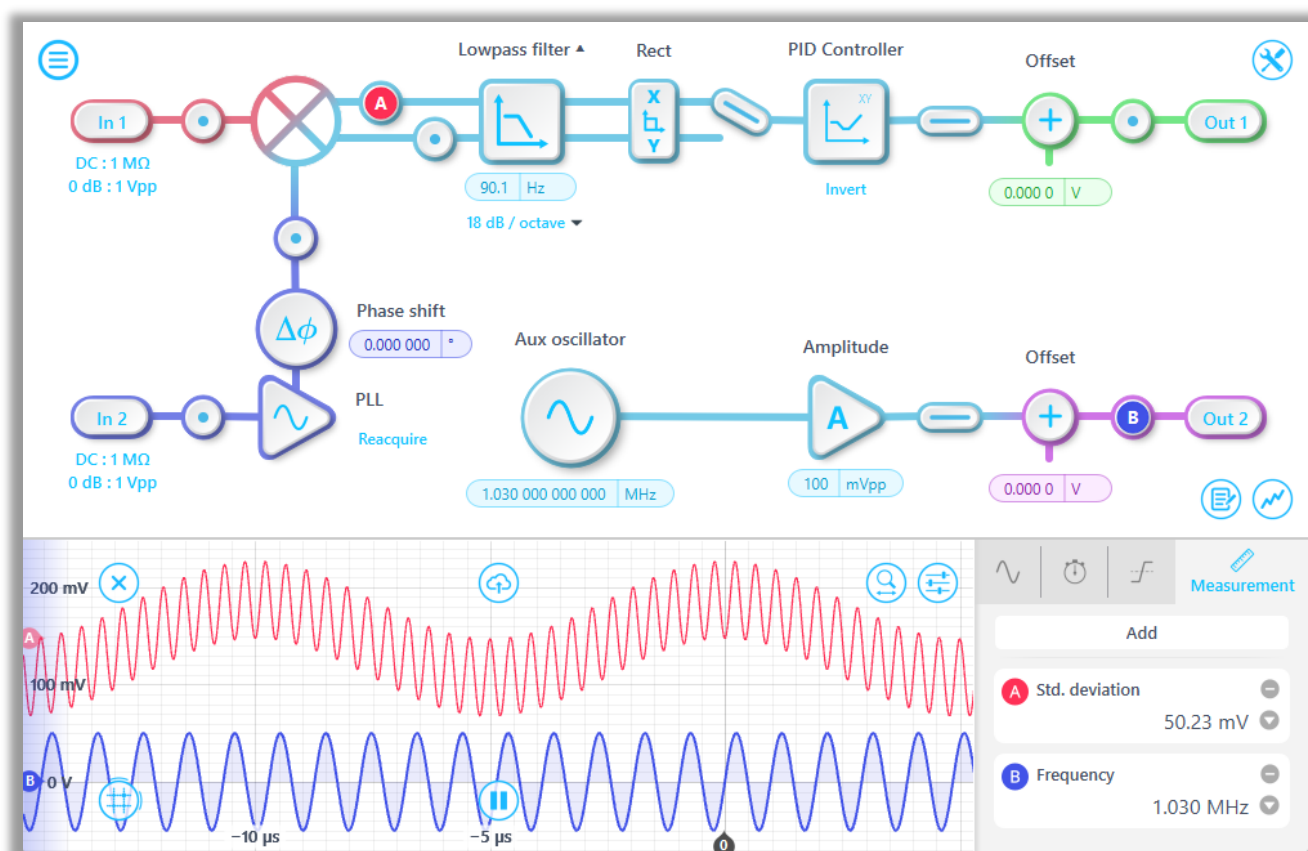

Features

- Measure XY or R θ simultaneously relative to an internal or external reference
- Observe and log signals at different stages in the digital signal processing chain using probe points⁸
- Demodulate signals at frequencies up to 200 MHz
- Reveal signals obscured by noise with more than 120 dB dynamic reserve

⁸ See [Moku:Lab Data Logger](#) or [Moku:Lab Oscilloscope](#) for specifications on integrated instruments



Specifications

Signal channel

Signal input

Input coupling	AC / DC
Input impedance	50 Ω / 1 M Ω
AC coupling corner (-3 dB)	100 Hz into 50 Ω 30 Hz into 1 M Ω
Frequency range	DC to 200 MHz
Input attenuation	0 dB / 20 dB
Input range	10 V _{pp} with 20 dB input attenuation 1 V _{pp} with 0 dB input attenuation
Input noise	< 200 nV/ $\sqrt{\text{Hz}}$ above 1 kHz at 1 V _{pp} input range < 30 nV/ $\sqrt{\text{Hz}}$ above 100 kHz at 1 V _{pp} input range < 20 nV/ $\sqrt{\text{Hz}}$ above 1 MHz at 1 V _{pp} input range

External reference

Reference input

Input coupling	AC / DC
Input impedance	50 Ω / 1 M Ω
Frequency range	DC to 200 MHz
Input attenuation	0 dB / 20 dB
External reference modes	Direct, phase-locked
Direct demodulation	$X = R \cos \theta$
Harmonic distortion	< -60 dBc

Phase-locked loop

PLL frequency range	10 Hz to 200 MHz
PLL tracking bandwidth	100 kHz, 10 kHz, 1 kHz, 100 Hz, 10 Hz, 1 Hz
Phase range	0 to 360°
Phase resolution	0.000 001°
Demodulation	XY / R θ
Orthogonality	90° \pm 0.000,002°

Internal reference

Internal reference waveforms

Waveform	Sine
----------	------



Internal reference waveforms

Frequency range	1 mHz to 200 MHz
Frequency resolution	1 μ Hz
Phase range	0 to 360°
Phase resolution	0.000 001°
Demodulation	XY / R θ
Orthogonality	90° \pm 0.000,002°
Output distortion	< -70 dBc for frequencies lower than 10 kHz < -60 dBc for frequencies greater than 10 kHz

Internal reference auxiliary output

Amplitude range	1 mV _{pp} to 2 V _{pp} into 50 Ω
Amplitude resolution	1 mV
Offset range	\pm 1 V
Output limit (AC + DC)	\pm 1 V
Amplitude accuracy	1%
Output impedance	50 Ω
Can be phase-locked to external 10 MHz timebase?	Yes

Demodulator

Demodulator characteristics

Sources	Internal reference oscillator, external direct, external with phase-locked loop
Types	Internal: XY / R θ External direct: X = Rcos θ External with PLL: XY / R θ
Filter mode	Low-pass filter
Filter cut-off frequency (-3dB)	300 mHz to 4.97 MHz
Filter time-constant	32 nanoseconds to 0.537 seconds
Filter slope	6, 12, 18, 24 dB per octave
Phase shift precision	0.000 001°
Dynamic reserve	> 120 dB

Signal output

Output characteristics

Modes	XY (cartesian mode); R θ (polar mode); Auxiliary Oscillator
Number of output channels	2
Channel 1 output	X/R



Output characteristics

Channel 2 output	Y/θ, auxiliary oscillator, or local oscillator
Output gain mode	Direct, PID ⁹
Gain range (direct)	-80 dB to 160 dB
Phase scale (Rθ mode)	1 V/cycle
Output voltage offset	± 1 V into 50 Ω
Output voltage range (AC + DC)	± 1 V into 50 Ω
Output impedance	50 Ω
D/A conversion	16-bit, 1 GSa/s, 300 MHz analog bandwidth

PID controller

Controller frequency range	100 mHz to 10 MHz
Proportional gain	± 120 dB (XY mode), ± 60 dB (Rθ mode)
Integrator crossover frequency	1.25 Hz to 125 kHz
Int. saturation crossover frequency	1.25 Hz to integrator crossover frequency
Integrator gain range	Proportional gain to +120 dB (XY mode), +80 dB (Rθ mode)
Differentiator crossover frequency	12.5 Hz to 1.25 MHz
Diff. saturation crossover frequency	Differentiator crossover frequency to 1.25 MHz
Differentiator gain range	Proportional gain to +120 dB (XY mode), +80 dB (Rθ mode)

⁹ Only one output may have a PID controller enabled at a time



Moku:Lab Logic Analyzer (Multi-instrument Mode)

Description

Moku:Lab Logic Analyzer¹⁰ is equipped with one digital input and two digital outputs with sampling rates up to 500 MSa/s. It supports 262k × 16 input sample depth and up to 32,764 × 16 output sample depth. Data, screenshots, and instrument settings can be captured and downloaded to the computer.

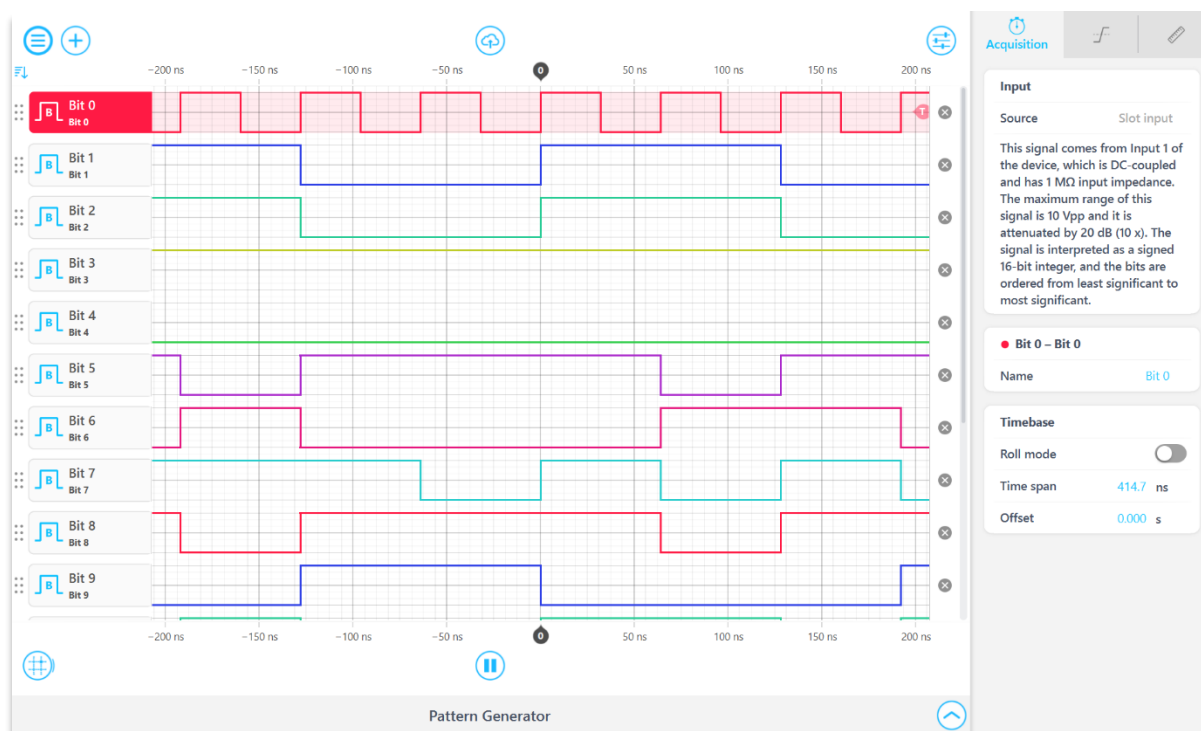

Features

- 16-bit single channel¹¹ digital input with sampling rate up to 500 MSa/s.
- Two outputs that include selectable clock, pulse, and random patterns, or upload a custom file.
- Ultra deep 262k × 16 points input memory depth, 32,764 × 16 points output memory depth.
- Decode up to two protocols at a time, including UART, SPI, I²C, and I²S.
- Powerful, intuitive graphical user interface with Python, LabVIEW, and MATLAB API support.

¹⁰ The Moku:Lab Logic Analyzer Pattern Generator is currently only supported in Multi-instrument Mode. These specifications are for a single Logic Analyzer instrument slot. Each Logic Analyzer instrument slot will add another input and two outputs.

¹¹ The Logic Analyzer input and output channels show 16 bits. The bits are ordered from least significant (Bit 0) to most significant (Bit 15). Each bit is added together to create the waveform for that input or output, they are not individual channels.



Specifications

Digital I/O¹²

Interface

Number of I/O	3
I/O sources	Input A, Output A, Output B

Horizontal characteristics

Acquisition

Sampling rate	500 MSa/s
Memory depth	262k points per channel
Maximum clock signal frequency	500 MHz
Clock divider	1 to 1,000,000

Generation

Sampling rate	1 GSa/s
Memory depth	32,786 points per channel
Maximum clock signal frequency	500 MHz

Trigger

Trigger

Trigger modes	Auto:	Triggers automatically after timeout (1 second if previously triggered, 0.05 seconds otherwise)
	Normal:	Triggers only on trigger event
	Single:	Triggers once on a trigger event. Press the 'play' button to re-trigger
Trigger sources	16 input bits	
Nth event	Trigger on the 1 st to 65,535 th event	
Holdoff	up to 10 seconds	
Trigger types	Edge or Combination ¹³	

Measurements

Measurements

¹² The Moku:Lab does not have a dedicated Digital I/O header like the Moku:Go does. Instead, it uses the BNC analog inputs and then converts the analog signal to a 16-bit digital signal or inter-slot 16-bit digital signals.

¹³ The triggering signal in Combination mode is determined by the logical operations performed on the edges or levels status of the pins.



Measurements

Time measurements	Frequency, phase, period, duty cycle, positive pulse width, negative pulse width
Math	AND, OR, XOR, NAND, NOR, XNOR

Protocol decoder

UART

Baud rate	1 to 2,000,000
Data width	5 bits to 9 bits
Stop width	1 bit to 2 bits
Parity	None, Even, Odd
Bit order	LSB first, MSB first
Max standard baud rate	921,600

SPI

CLK	Serial clock bit
CS	Chip select bit
DATA	Serial data bit
Data width	5 bits to 9 bits
Bit order	LSB first, MSB first
Clock polarity	Idle low, Idle high
Clock phase	Sample on leading, Sample on trailing
Max decoder frequency	15 MHz

I²C

Address size	7 bits
SCL ¹⁴	Serial clock bit
SDA	Serial data bit
Max decoder frequency	>1 MHz

I²S

SCK	Serial clock bit
WS	Word select bit
SD	Serial data bit
Bit order	LSB first, MSB first

¹⁴ Some protocols like I²C and I²S require the user to select a bit for their input data to the protocol decoder. Ensure the bits labelled on the interface match the bits you set for your input data.



I²S

Offset	Number of clock cycle to wait after WS transition before data transmission starts
Data Width	2 bits to 32 bits
Max decoder frequency	20 MHz

Saving data

Exporting data

File formats	Binary: records data using a proprietary LI format for high-speed data logging. Can be converted to .csv, .txt, .mat, .npy, and HDF5.
Export modes	Dropbox, email, iCloud, and My Files (iOS 11 / Windows 10 or later)

Export types

Traces	Save 1024 points of data from each visible input bit in the current time span
Protocol data	Save protocol decoder states and data as comma-separated values
Screenshot	Save the app window as a PNG or JPG
Settings	Save the current instruments settings to a text file
Measurements	Save all active measurements as comma-separated values
High-res data	Save up to 262 kpts per active bit



Moku:Lab Logic Analyzer (Single-instrument Mode)

Description

Moku:Lab Logic Analyzer¹⁵ is equipped with three digital inputs with sampling rates up to 500 MSa/s. It supports 262k × 3 input sample depth. Data, screenshots, and instrument settings can be captured and downloaded to the computer.



Features

- Three digital channel with sampling rate up to 500 MSa/s.
- Ultra deep 262k × 3 points input memory dept.
- Decode up to two protocols at a time, including UART, SPI, I²C, and I²S.
- Powerful, intuitive graphical user interface with Python, LabVIEW, and MATLAB API support.

¹⁵ The Moku:Lab Logic Analyzer Pattern Generator is currently only supported in Multi-instrument Mode. These specifications are for a Single-instrument Mode Logic Analyzer.



Specifications

Analog inputs¹⁶

Interface

Number of Inputs	3
Input sources	Input 1, Input 2, External Trigger
Threshold voltage range	-5 V to 5 V

Horizontal characteristics

Acquisition

Sampling rate	500 MSa/s
Memory depth	262k points per channel
Maximum clock signal frequency	500 MHz
Clock divider	1 to 1,000,000

Trigger

Trigger

Trigger modes	Auto:	Triggers automatically after timeout (1 second if previously triggered, 0.05 seconds otherwise)
	Normal:	Triggers only on trigger event
	Single:	Triggers once on a trigger event. Press the 'play' button to re-trigger
Trigger sources	Input 1, Input 2, Ext. trig.	
Nth event	Trigger on the 1 st to 65,535 th event	
Holdoff	up to 10 seconds	
Trigger types	Edge or Combination	

Measurements

Measurements

Time measurements	Frequency, phase, period, duty cycle, positive pulse width, negative pulse width
Math	AND, OR, XOR, NAND, NOR, XNOR

Protocol decoder

UART

¹⁶ The Moku:Lab does not have a dedicated Digital I/O header like the Moku:Go does. Instead, it uses the BNC analog inputs and then converts the analog signal to a digital signal using the user provided threshold range.



UART

Data width	5 bits to 9 bits
Stop width	1 bit to 2 bits
Parity	None, Even, Odd
Baud rate	1 to 2,000,000
Bit order	LSB first, MSB first
Max standard baud rate	921,600

SPI

CLK	Serial clock bit
CS	Chip select bit
DATA	Serial data bit
Data width	5 bits to 9 bits
Bit order	LSB first, MSB first
Clock polarity	Idle low, Idle high
Clock phase	Sample on leading, Sample on trailing
Max decoder frequency	15 MHz

I²C

Address size	7 bits
SCL ¹⁷	Serial clock bit
SDA	Serial data bit
Max decoder frequency	>1 MHz

I²S

SCK	Serial clock bit
WS	Word select bit
SD	Serial data bit
Bit order	LSB first, MSB first
Offset	Number of clock cycle to wait after WS transition before data transmission starts
Data Width	2 bits to 32 bits
Max decoder frequency	20 MHz

Saving data

Exporting data

¹⁷ Some protocols like I²C and I²S require the user to select a bit for their input data to the protocol decoder. Ensure the bits labelled on the interface match the bits you set for your input data.



Exporting data

File formats	Binary: records data using a proprietary LI format for high-speed data logging. Can be converted to .csv, .txt, .mat, .npy, and HDF5.
Export modes	Dropbox, email, iCloud, and My Files (iOS 11 / Windows 10 or later)

Export types

Traces	Save 1024 points of data from each visible input bit in the current time span
Protocol data	Save protocol decoder states and data as comma-separated values
Screenshot	Save the app window as a PNG or JPG
Settings	Save the current instruments settings to a text file
Measurements	Save all active measurements as comma-separated values
High-res data	Save up to 262 kpts per active bit



Moku:Lab Oscilloscope

Description

The Moku:Lab Oscilloscope features two 500 MS/s analog input channels with 200 MHz analog bandwidth, 10 Vpp input voltage range, and user-configurable AC / DC coupling and 50 Ω / 1 M Ω impedance. The Oscilloscope also features two integrated waveform generators capable of producing sine waves at up to 250 MHz and square, sawtooth and triangle waves at up to 100 MHz, enabling it to stimulate a system and measure its response simultaneously.



Features

- Analyse two voltage channels with a vertical range of ± 5 Volts, 200 MHz analog bandwidth, and maximum sampling rate of 500 MSa/s
- Measure data in precision mode to increase measurement resolution by rejecting noise
- Synthesize sine, square, ramp, pulse, and DC waveforms
- Analyse signals in XY mode
- Quickly measure waveform characteristics, trends and statistics



Specifications

Vertical characteristics

Voltage

Channels	2
Input coupling	AC / DC
Input impedance	50 Ω / 1 M Ω
Input bandwidth (-3 dB)	> 200 MHz into 50 Ω
Input voltage range	± 5 V
Input voltage noise	< 200 nV/ $\sqrt{\text{Hz}}$ above 1 kHz at 1 V _{pp} input range < 30 nV/ $\sqrt{\text{Hz}}$ above 100 kHz at 1 V _{pp} input range < 20 nV/ $\sqrt{\text{Hz}}$ above 1 MHz at 1 V _{pp} input range
Vertical resolution ¹⁸	12 bits at 500 MSa/s (ADC resolution) 13 bits at 125 MSa/s 22 bits at 1 kSa/s
Channel-to-channel isolation	> 40 dB

Horizontal characteristics

Time

Time mode	Normal, Roll
Horizontal range	2 ns/div to 20 s/div
Delay range	Pre-trigger: 16 kSamples Greater of 32.768 μ s or screen width Post-trigger: 2 ³⁰ samples 2.147 s to 10 ks

Acquisition

Acquisition mode	Normal, Precision, and Deep memory
Maximum sampling rate	500 MSa/s
Memory depth	4.2 M samples per channel 37.4 ms at 2 ms/div
Averaging (linear)	Off, 2 to 100 waveforms
Persistence	Off, 100 ms to 10 s, infinite
Interpolation	Linear, SinX/X, Gaussian

Trigger

Trigger

¹⁸Higher effective number of bits (ENOB) above the physical ADC specification is only available in precision mode.



Trigger

Trigger modes	Auto: Triggers automatically after timeout (1 second if previously triggered, 0.05 seconds otherwise)
	Normal: Triggers only on trigger event
	Single: Triggers once on a trigger event. Press the 'play' button to re-trigger
Trigger sources	Input 1, Input 2, Output 1, Output 2, External
Nth event	Trigger on the 1 st to 65,535 th event
Holdoff	1 nanosecond to 10 seconds
Trigger types	Edge: Rising edge, falling edge, both edges Pulse: Positive / negative polarity <ul style="list-style-type: none">10.0 seconds > pulse width > 8 nanoseconds

Trigger sensitivity

Sensitivity modes	Auto: Automatically configures trigger sensitivity based on horizontal and vertical scales Select <i>Noise Reject</i> or high-frequency <i>HF Reject</i> options
	Manual: Manually configure trigger sensitivity
Manual modes	Relative, Absolute
Hysteresis	Relative: 0.01 div to 5.00 div Absolute: 100 μ V to 1.00 V

Measurements

Measurements

Time measurements	Frequency, period, phase, duty cycle, positive pulse width, negative pulse width, rise time, fall time, rise rate, fall rate
Amplitude measurements	Peak-to-peak, amplitude, maximum, minimum, mean, cycle mean, RMS, cycle RMS, standard deviation, high-level, low-level, overshoot, undershoot, fringe vis.
Math	Add, subtract, multiply, divide, XY mode, integrate, differentiate, FFT, min hold, max hold, arbitrary equation mode (using equation editor)
Visualisations	Histogram, time trend

Cursors

Maximum voltage cursors	5 per channel
Maximum time cursors	5 per channel
Voltage cursor options	Manual, track mean, track maximum, track minimum, maximum hold, minimum hold
User defined reference	A single cursor can be set as a reference for differential measurements using all other active cursors

Integrated waveform synthesizer

Synthesizer



Synthesizer

Channels	2
Output impedance	50 Ω
Waveforms ¹⁹	Sine, Square, Ramp, Pulse, Noise, DC
Output frequency range	1 mHz to 250 MHz
Output voltage range	± 1 V into 50 Ω

¹⁹ Modulation not available for waveforms synthesized using the oscilloscope instrument.



Moku:Lab Phasemeter

Description

The Moku:Lab Phasemeter measures phase of up to two input signals with better than $6 \mu\text{radian}$ precision from 1 kHz up to 200 MHz. Based on a digitally implemented phase-locked loop architecture, the Phasemeter provides exceptional dynamic range, zero dead-time and measurement precision that exceeds the performance of conventional lock-in amplifiers and frequency counters.

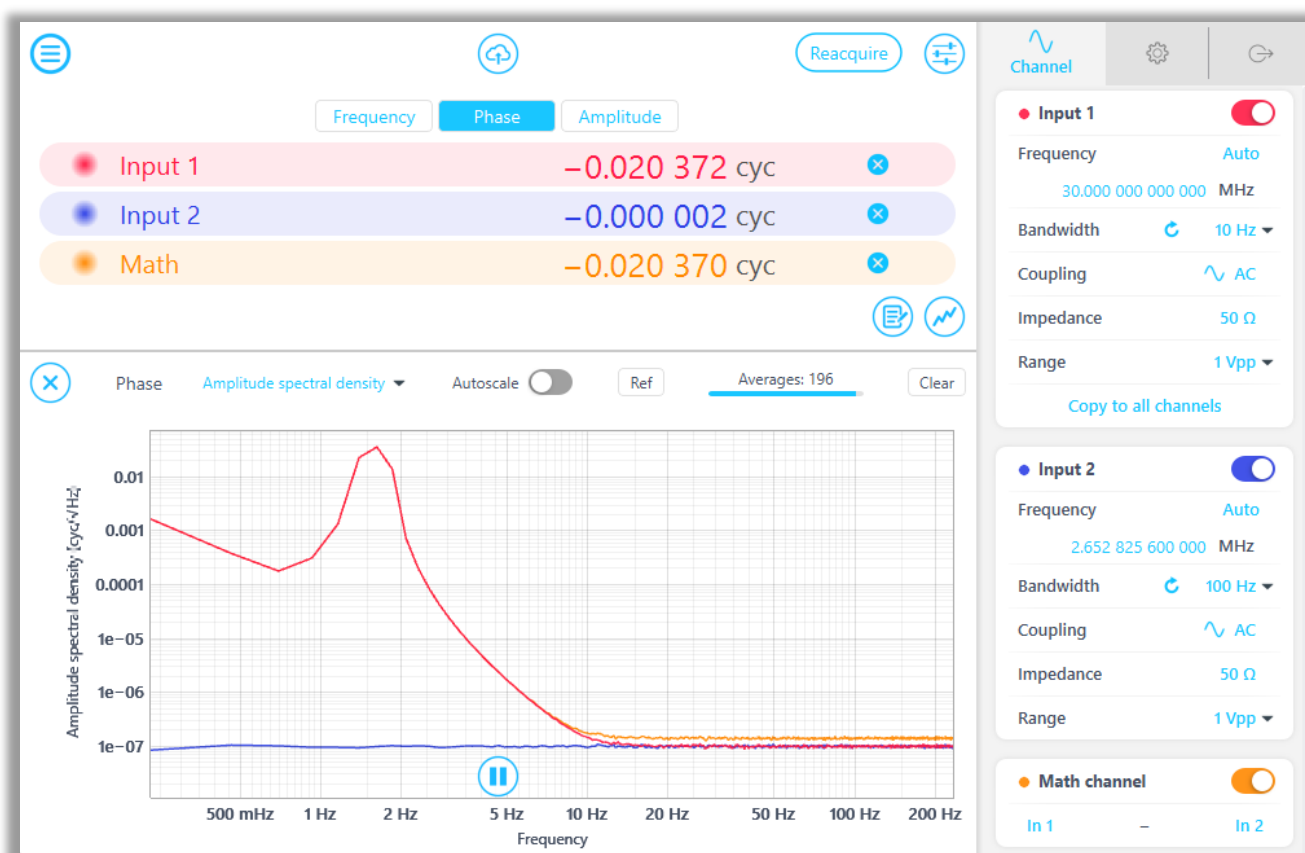

Features

- Measure phase over a range of more than 65 million cycles with better than $1 \mu\text{cycle}$ precision
- Simultaneously measure the phase, frequency and amplitude of an incoming signal
- Acquire data at up to 15.2 kSa/s
- Observe measurement data in the frequency domain using the Phasemeter's integrated spectral analysis toolkit



Specifications

Inputs

Input characteristics

Input frequency range	1 kHz to 200 MHz
Input voltage range	± 5 V into 50 Ω
Input impedance	50 Ω / 1 M Ω
Input coupling	AC / DC

Measurement

Measurement characteristics

Frequency set-point precision	10 μ Hz	
Modes of operation	Auto-acquire	Automatically determines input frequency for signals above 1 MHz
	Manual	Initializes the phasemeter to a specific frequency
Tracking bandwidth	1 Hz / 10 Hz / 100 Hz / 1 kHz / 10 kHz / 100 kHz (user selectable)	
Frequency precision	Input Frequency	Precision (f = Fourier frequency)
	< 10 MHz	$f \times 10$ μ Hz/ $\sqrt{\text{Hz}}$ from 1 mHz to 1 kHz
	< 100 MHz	$f \times 20$ μ Hz/ $\sqrt{\text{Hz}}$ from 1 mHz to 1 kHz
	> 100 MHz	20 μ Hz/ $\sqrt{\text{Hz}}$ below 1 Hz $f \times 20$ μ Hz/ $\sqrt{\text{Hz}}$ from 1 Hz to 1 kHz
Phase precision ²⁰	< 10 MHz	100 nCycles/ $\sqrt{\text{Hz}}$ above 1 Hz
	< 100 MHz	2 μ Cycles/ $\sqrt{\text{Hz}}$ above 1 Hz
	> 100 MHz	20 μ Cycles/ $\sqrt{\text{Hz}}$ above 1 Hz

Data visualisation

Visualisations	Timeseries, Power Spectral Density, Amplitude Spectral Density, Coherence, Rayleigh Spectrum, Allan Deviation
----------------	---

Saving data

Saving data

Logging rates	30 Sa/s, 119 Sa/s, 477 Sa/s, 1.9 kSa/s, 15.2 kSa/s
File formats	Binary: records data using a proprietary LI format for high-speed data logging. Note: data saved using the LI format can be converted to plain text using the LI file converter available here: https://www.liquidinstruments.com/software/utilities/

²⁰ Frequency and phase measurement precision is limited by sampling jitter at low Fourier frequencies.



Saving data

Export modes	SD Card, Dropbox, E-mail and iCloud, My Files (iOS 11)
Delayed log start time	Up to 240 hours
Log duration	1 second up to 10000 hours

Synthesizer

Synthesizer²¹

Channels	2
Output impedance	50 Ω
Waveform shape	Sine
Output modes	Manual, phase-locked to input signal
Sampling rate	1 GSa/s per channel
Voltage range	± 1 V into 50 Ω

²¹ Where not stated, the phasemeter's synthesizer specifications match those of the Moku:WaveformGenerator instrument.



Moku:Lab PID Controller

Description

The Moku:Lab PID Controller features two fully configurable PID controllers with an open loop bandwidth of 14.11 MHz. This enables them to be used in applications requiring both low and high feedback bandwidths such as temperature and laser frequency stabilization. The PID Controller can also be used as a lead-lag compensator by saturating the integral and differential controllers with independent gain settings.

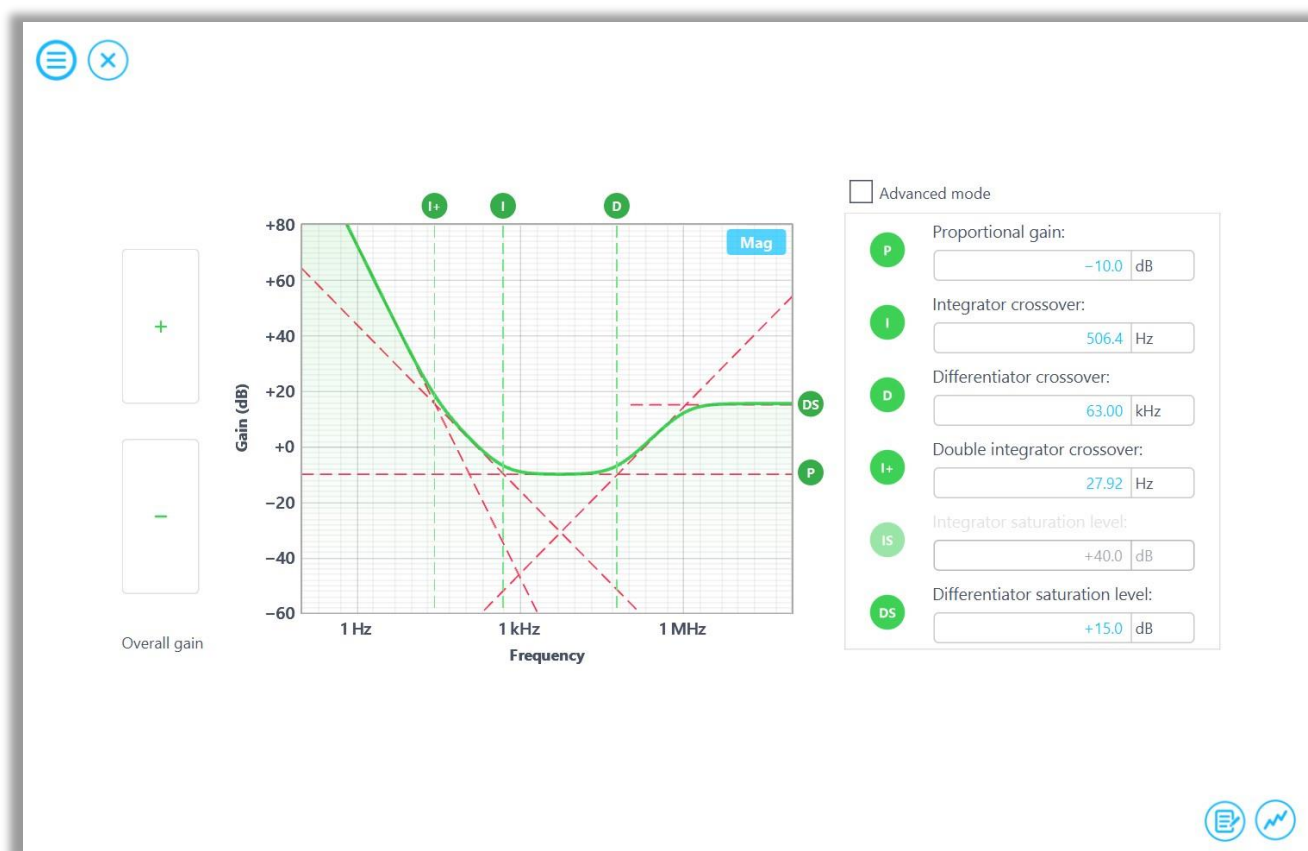

Features

- Rapidly configure the PID controller's frequency response using an interactive Bode plot
- Observe and log signals at different stages in the digital signal processing chain using probe points²²
- Control up to two channels of data simultaneously with the ability to blend input signals using a control matrix
- Configure controller parameters in basic or advanced editing modes

²² See [Moku:Lab Data Logger](#) or [Moku:Lab Oscilloscope](#) for specifications on integrated instruments



- Implement lead-lag compensators using saturated integral and differential controllers

Specifications

Inputs

Input characteristics

Channels	2
Input control matrix coefficients (linear gain)	-20 to +20
Input impedance	50 Ω / 1 M Ω
Input coupling	AC / DC
Input attenuation	0 dB / 20 dB
Input voltage range	± 0.5 V into 50 Ω with 0 dB attenuation

Controller

General characteristics

Gain profiles	Proportional (P), integral (I), differential (D), double-integral (I+), integral saturation (IS), differential saturation (DS)
Maximum bandwidth	100 kHz with a phase delay of 30°
Input / output offset range	± 1 V
Output limit (AC + DC)	± 1 V into 50 Ω
Offset precision	100 μ V

Gain characteristics

Gain profiles	Proportional (P), integral (I), differential (D), double-integral (I+), integral saturation (IS), differential saturation (DS)
Controller frequency range	100 mHz to 10 MHz
Input / output offset range	± 1 V
Offset precision	100 μ V
Proportional gain	± 60 dB
Integrator crossover frequency	1.25 Hz to 125 kHz
Double integrator crossover frequency	1.25 Hz to integrator crossover frequency
Integral saturation level	Between proportional gain and +60 dB The integrator saturation crossover frequency cannot be lower than 1.25 Hz
Differentiator crossover frequency	12.5 Hz to 1.25 MHz
Differentiator saturation level	Between proportional gain and +60 dB The differentiator saturation crossover frequency cannot be higher than 1.25 MHz



Measurements

Integrated oscilloscope

Acquisition mode	Normal, Precision, and Deep memory
Maximum sampling rate	500 MSa/s
Memory depth	4.2 M samples per channel 37.4 ms at 2 ms/div
Averaging (linear)	Off, 2 to 100 waveforms
Persistence	Off, 100 ms to 10 s, infinite
Interpolation	Linear, SinX/X, Gaussian

Measurements

Time measurements	Frequency, period, phase, duty cycle, positive pulse width, negative pulse width, rise time, fall time, rise rate, fall rate
Amplitude measurements	Peak-to-peak, amplitude, maximum, minimum, mean, cycle mean, RMS, cycle RMS, standard deviation, high-level, low-level, overshoot, undershoot, fringe vis.
Math	Add, subtract, multiply, divide, XY mode, integrate, differentiate, FFT, min hold, max hold, arbitrary equation mode (using equation editor)
Visualisations	Histogram, time trend



Moku:Lab Spectrum Analyzer

Description

The Moku:Lab Spectrum Analyzer allows you to observe input signals in the frequency domain between DC and 250 MHz. View two channels of data simultaneously with a resolution bandwidth as low as 1.88 Hz over a minimum span of 100 Hz. The Spectrum Analyzer also features two integrated waveform generators capable of producing sine waves at up to 250 MHz.



Features

- DC to 250 MHz frequency range
- 100 Hz to 250 MHz frequency span
- Quickly measure important metrics by dragging measurement cursors onto features of interest using the iPad's multi-touch interface
- View spectral data in units of Volts or dBm as either power or power spectral density



Specifications

Frequency

Frequency

Range	DC to 250 MHz
Span	100 Hz to 250 MHz

Resolution bandwidth (RBW)

Modes	Auto	Automatically sets the RBW based on the current span and window function
	Manual	Allows the user to manually set the RBW within the limits tolerated by the span and window function
	Min	Sets the RBW at the minimum possible value for the current span and window function The minimum RBW is 1.88 Hz
Windows	Rectangular, Bartlett, Hann, Hamming, Flat Top, Nuttall, Gaussian, Kaiser, Blackman-Harris	

Amplitude

Voltage

Channels	2
Input coupling	AC / DC
Input impedance	50 Ω / 1 M Ω
Input attenuation	0 dB / 20 dB
Input bandwidth (-3 dB)	> 200 MHz into 50 Ω > 180 MHz into 1 M Ω
Input voltage range	\pm 0.5 V into 50 Ω with 0 dB attenuation \pm 5 V into 50 Ω with 20 dB attenuation
Input voltage sensitivity	-130 dBm with 0 dB attenuation at minimum RBW

Display

Scales	Vrms, Vpp, dBm, dBV
Display modes	Power, Power Spectral Density (PSD)
Video bandwidth (VBW)	930 mHz to 2.4 MHz depending on span
Averages	1 to 100
Persistence	100 ms to 10 s, infinite, off

Synthesizer

Synthesizer

Channels	2
----------	---



Synthesizer

Output impedance	50 Ω
Waveforms ²³	Sine
Output frequency range	1 mHz to 250 MHz
Output voltage range	± 1 V into 50 Ω

²³ Modulation not available for waveforms synthesized using the oscilloscope instrument.



Moku:Lab Waveform Generator

Description

The Moku:Lab Waveform Generator enables users to generate two independent waveforms with a sampling rate of 1 GSa/s, a maximum frequency of 250 MHz and a output voltage range of ± 1 V into 50 Ω . Select between sine, square, ramp, pulsed or DC waveform shapes. Modulate the phase, frequency, or amplitude, or generate triggered bursts or sweeps from an internal or external source.

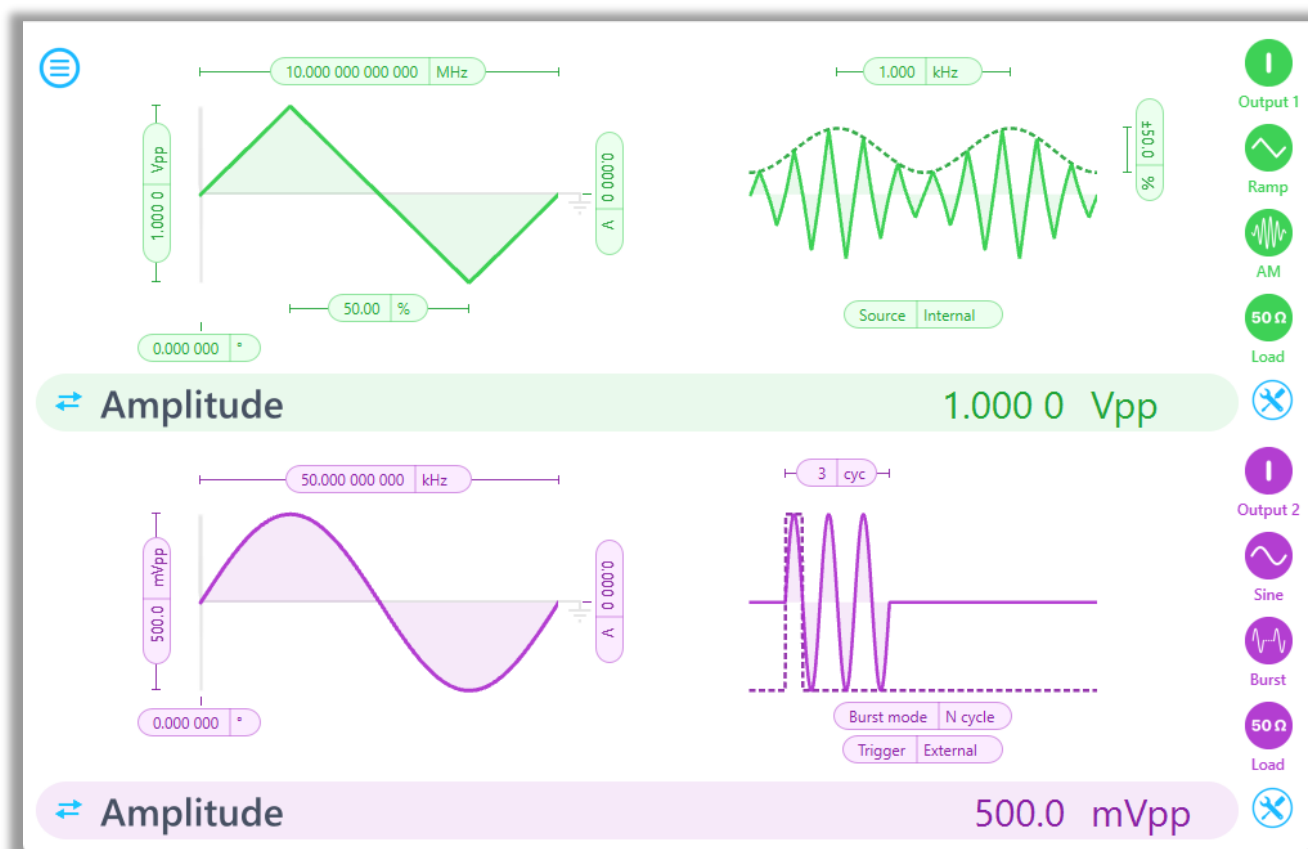

Features

- Generate sine waves from 1 mHz to 250 MHz
- Generate square and ramp waves from 1 mHz up to 100 MHz
- Generate pulsed waveforms with a minimum pulse width of 4 ns at up to 100 MHz
- Modulate waveforms in amplitude, frequency and phase at up to 62.5 MHz using both internal and external sources



Specifications

Common characteristics

Overview

Channels	2
Bandwidth (-3 dB)	300 MHz into 50 Ω
Sampling rate	1 GSa/s per channel
Frequency resolution	1 μ Hz
Output impedance	50 Ω
Waveforms	Sine, Square, Ramp, Pulse, Noise, DC

Amplitude

Range	1 mV _{pp} to 2 V _{pp} into 50 Ω
Offset error	< 500 μ V into 50 Ω
Resolution	100 μ V
Channel isolation	> 40 dB from DC to 200 MHz
Units	V _{pp} , dBm

DC offset

Range (peak AC + DC)	\pm 1 V into 50 Ω
Resolution	100 μ V

Phase offset

Range	0° to 360°
Resolution	0.000 001°

Waveform characteristics

Sine

Frequency range	1 MHz to 250 MHz	
Amplitude flatness (into 50 Ω)	< 100 kHz	< 0.03 dB
	100 kHz to 10 MHz	< 0.08 dB
	10 MHz to 250 MHz	< 0.12 dB
Total harmonic distortion	< 0.5% (1.5 MHz, 5 harmonics)	
SFDR	> 50 dBc for frequencies less than 20 MHz	

Square



Square

Frequency range	1 mHz to 100 MHz	
Edge time ²⁴	< 2.3 ns into 50 Ω	At frequencies < 75 MHz
	< 2.6 ns into 1 M Ω	
	< 3.6 ns into 50 Ω	At frequencies < 100 MHz
	< 2.8 ns into 1 M Ω	
Overshoot	< 2% for rise times greater than 8 ns < 15% for rise times between 2 ns and 8 ns	
Jitter (cycle-to-cycle)	< 1 ns	

Ramp

Frequency range	1 mHz to 100 MHz	
Symmetry ²⁵	20% to 80% at 100 MHz	
	4% to 96% at 20 MHz	
	0% to 100% at 5 MHz	
Linearity	Below 1 MHz	> 99%
	Between 1 MHz and 50 MHz	> 98%
	Above 50 MHz	> 95%

Pulse

Frequency range	1 mHz to 100 MHz	
Period range	1000 s to 10 ns	
Pulse width	4 ns to (period - edge time)	
Edge time	4 ns to pulse width	
Edge time resolution	1 ns	
Overshoot	< 2% for rise times greater than 8 ns	
	< 15% for rise times between 2 ns and 8 ns	
Jitter	Same as square wave	

Noise

Amplitude	Up to 2 V _{pp} , minimum 1 mV
Resolution	0.1 mV

Modulation

Amplitude

Carrier waveforms	Sine, Square, Ramp, Pulse, Noise
-------------------	----------------------------------

²⁴ Measured for a 2 V_{pp} square wave at 10 MHz using a 4 GSa/s MSO7104B Mixed Signal Oscilloscope.

²⁵ Symmetry is limited by the minimum rise time of 2 ns and number of harmonics required to maintain a linearity of more than 99%.



Amplitude

Source	Ch1: Input 1, Input 2, Output 2, Internal Ch2: Input 1, Input 2, Output 1, Internal
Internal modulation	Sine
Frequency	1 mHz to 62.5 MHz
Depth	0% to 100%

Frequency

Carrier waveforms	Sine, Square, Ramp, Pulse
Source	Ch1: Input 1, Input 2, Output 2, Internal Ch2: Input 1, Input 2, Output 1, Internal
Internal modulation	Sine
Frequency	DC to 62.5 MHz
Deviation (carrier + deviation)	DC to 250 MHz

Phase

Carrier waveforms	Sine, Square, Ramp, Pulse
Source	Ch1: Input 1, Input 2, Output 2, Internal Ch2: Input 1, Input 2, Output 1, Internal
Internal modulation	Sine
Frequency	DC to 62.5 MHz
Phase shift	0.001° to 3,600.000°

Burst

Modes of Operation	Start, N-Cycle, Gated
N-Cycle range	1 to 1,000,000
Trigger Sources	Ch1: Input 1, Input 2, Output 2, External, Internal Ch2: Input 1, Input 2, Output 1, External, Internal
Nominal Trigger Level	Input Channel: 1.8 V Output Channel: 0.5 V External: 1.2 V

Sweep

Sweep Frequency Start/End	Sine: 1 mHz to 250 MHz Square, Ramp, Pulse: 1 mHz to 100 MHz
Sweep Time	1 ms to 1 ks
Trigger Sources	Ch1: Input 1, Input 2, Output 2, External, Internal Ch2: Input 1, Input 2, Output 1, External, Internal
Nominal Trigger Level	Input Channel: 1.8 V Output Channel: 0.5 V External: 1.2 V



Pulse Width Modulation

Pulse Width Deviation	Programmable pulse width deviation with warnings if pulse width <0 or exceeds pulse period
PWM Sources	Ch1: Input 1, Input 2, Output 2, Internal Ch2: Input 1, Input 2, Output 1, Internal



Moku:Lab Multi-Instrument Mode

Description

Moku:Lab Multi-Instrument Mode enables you to deploy up to two instruments and operate them simultaneously. These instruments can exchange high-speed, low latency signals between themselves in the digital domain at 2 Gb/s. Source signals from the real world via the ADCs and drive signals to the real world via the high-speed digital-to-analog converters. Connect instrument slots to build customized signal processing chains or drop a custom configuration in one slot with Moku Cloud Compile.

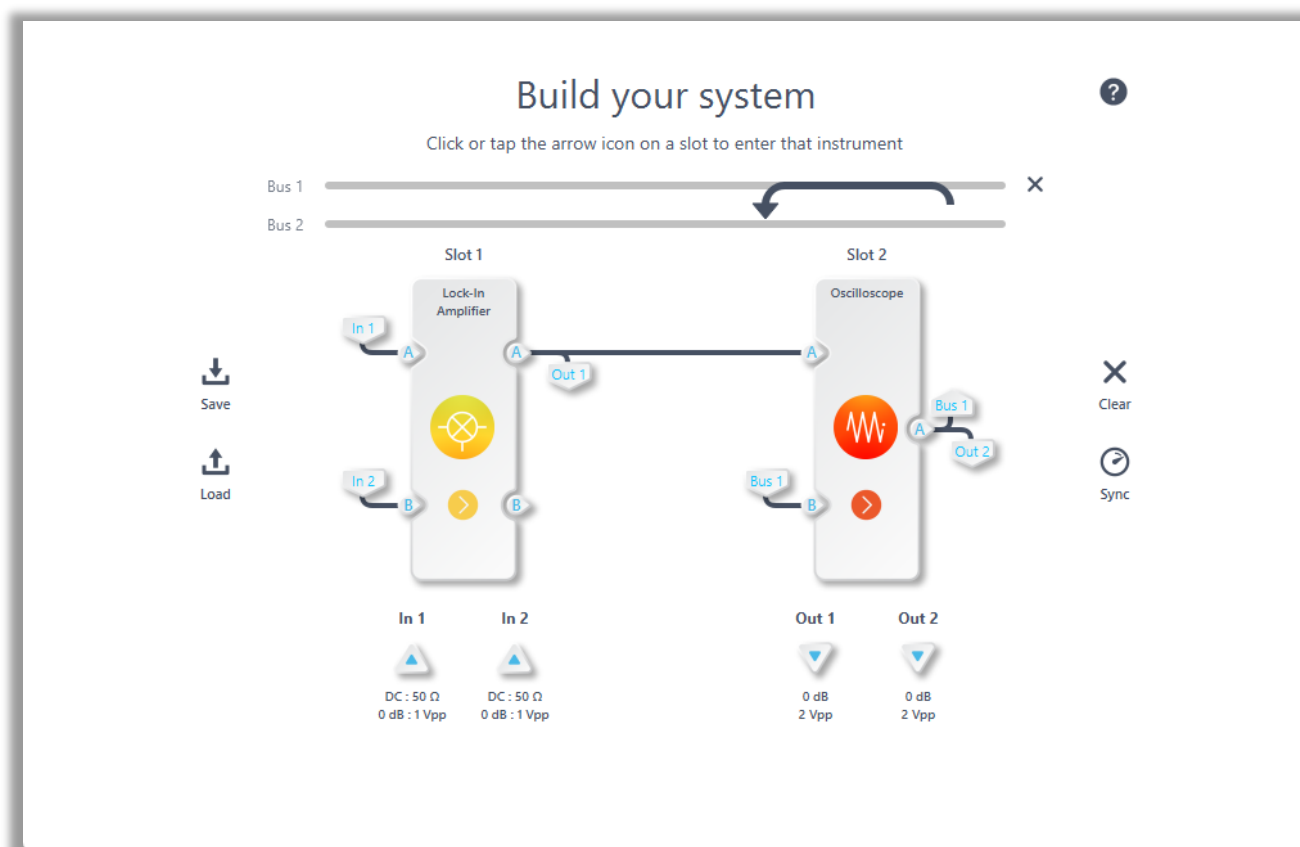

Features

- Configure two independent instruments, operating simultaneously
- Each of the instrument slots has up to two inputs and two outputs
- Flexible multiplexing allows all two slots to access all two ADC inputs and all two DAC outputs



- High-speed, 2 Gb/s inter-instrument communication with drag and drop setup
- Configurable input and output ranges, one-touch slot synchronization

Specifications

Common characteristics

Overview

Instruments	Up to 2, each with up to 2 inputs and 2 outputs
Inputs / outputs	2 analog inputs, 2 analog outputs
Input ranges	1 V _{pp} into 50 Ω with 0 dB attenuation 10 V _{pp} into 50 Ω with 20 dB attenuation
Input bandwidth	200 MHz
Input sampling rate	500 MSa/s per channel
Input impedance	50 Ω / 1 M Ω
Output ranges	2 V _{pp} into 50 Ω
Output bandwidth	300 MHz at 2 V _{pp}
Output sampling rate	500 MSa/s per channel
Output impedance	50 Ω

Instrument slot

Inter-slot communication	2 channels, each at 16 bits at 125 MHz / 2 Gb/s
Available instruments	Arbitrary Waveform Generator Data Logger Digital Filter Box FIR Filter Builder Frequency Response Analyzer Laser Lock Box Lock-in Amplifier Logic Analyzer Oscilloscope Phasemeter PID Controller Spectrum Analyzer Waveform Generator Moku Cloud Compile

This information is subject to change without notice.

© 2023 Liquid Instruments. All rights reserved.